

User Manual

for S6 Series Grid Tie Inverter



Applicable models

S6-GC25K-US

S6-GC33K-US

S6-GC36K-US

S6-GC40K-US

S6-GC50K-US

S6-GC60K-US

S6-GC-30K-LV-US

Important notes

- Product specifications are subject to change without notice. Every attempt has been made to make this document complete, accurate and up-to-date. Individuals reviewing this document and installers or service personnel are cautioned, however, that EC reserves the right to make changes without notice and shall not be responsible for any damages, including indirect, incidental or consequential damages caused by reliance on the material presented including, but not limited to, omissions, typographical errors, arithmetical errors or listing errors in the material provided in this document.
- EC accepts no liability for customers' failure to comply with the instructions for correct installation and will not be held responsible for upstream or downstream systems Solis equipment has supplied.
- The customer is fully liable for any modifications made to the system; therefore, any hardware or software modification, manipulation, or alteration not expressly approved by the manufacturer shall result in the immediate cancellation of the warranty.
- Given the countless possible system configurations and installation environments, it is essential to verify adherence to the following:
 - There is sufficient space suitable for housing the equipment.
 - Airborne noise produced depending on the environment.
 - Potential flammability hazards.
- EC will not be held liable for defects or malfunctions arising from:
 - Improper use of the equipment.
 - Deterioration resulting from transportation or particular environmental conditions.
 - Performing maintenance incorrectly or not at all.
 - Tampering or unsafe repairs.
 - Use or installation by unqualified persons.
- This product contains lethal voltages and should be installed by qualified electrical or service personnel having experience with lethal voltages.

Table of Contents

1 Introduction

2 Safety

3 Installation

4 Communication

5 Commissioning

6 Settings

7 Maintenance

8 Troubleshooting

9 Specifications

10 Appendix

Table of Contents

1. Introduction	1
1.1 Product Description	1
1.2 Front Panel Display	2
1.3 LED Status Indicator Lights	2
1.4 Unpacking	3
1.5 Inverter Circuit Diagram	4
1.6 Tools Required for Installation	4
1.7 Storage	5
1.8 Notice of Disposal	5
2. Safety Instruction	6
2.1 Safety symbols	6
2.2 General safety instructions	6
2.3 Notice for use	7
2.4 Protection Circuitry and Controls	7
3. Installation	8
3.1 Environmental considerations	8
3.1.1 Select a location for the inverter	8
3.1.2 Other environmental considerations	9
3.2 Product handling	11
3.3 Mounting the Inverter	12
3.3.1 Wall mounting	13
3.3.2 Rack mounting	16
3.4 Electrical Connections	19
3.4.1 Grounding	20
3.4.2 Connect PV side of inverter	22
3.4.3 Connect grid side of inverter	24
4. Communication & Monitoring	29
4.1 RS485 communication	29
5. Commissioning	32
5.1 Selecting the appropriate grid standard	32
5.1.1 Verifying grid standard for country of installation	32
5.2 Changing the grid standard	32
5.2.1 Procedure to set the grid standard	32
5.3 Setting a custom grid standard	33
5.4 Preliminary checks	34
5.4.1 DC configuration	34
5.4.2 AC configuration	35
5.4.3 DC Connections	35
5.4.4 AC Connections	35
6. Settings	36
6.1 Start-up procedure	36
6.2 Shutdown procedure	36
6.3 Main Menu	37
6.4 Information	37

Table of Contents

6.4.1 Lock screen	39
6.5 Settings	39
6.5.1 Set Time	39
6.5.2 Set Address.....	39
6.6 Advanced Info - Technicians Only	40
6.6.1 Alarm Message	40
6.6.2 Running Message	40
6.6.3 Version	41
6.6.4 Daily Energy	41
6.6.5 Monthly Energy	41
6.6.6 Yearly Energy	42
6.6.7 Daily Records	42
6.6.8 Communication Data	42
6.6.9 Warning Message	42
6.7 Advanced Settings - Technicians Only	43
6.7.1 Selecting Standard	43
6.7.2 Grid ON/OFF	44
6.7.3 Clear Energy	44
6.7.4 Reset Password	44
6.7.5 Power control	45
6.7.6 Calibrate Energy	45
6.7.7 Special Settings	45
6.7.8 STD Mode settings	46
6.7.9 Restore Settings	56
6.7.10 HMI Update	57
6.7.11 External EPM Set	57
6.7.12 Restart HMI	57
6.7.13 Debug Parameter	58
6.7.14 Fan Test	58
6.7.15 DSP Update	59
6.7.16 Compensation Set	59
6.7.17 I/V Curve	60
6.8 AFCI function	61
7. Maintenance	62
7.1 Anti-PID Function	62
7.2 Fan Maintenance	63
8. Troubleshooting	64
8.1 Current Alarm	64
8.2 Alarm History	64
8.3 Error Messages.....	64
9. Specifications	71
10. Appendix	78

1.1 Product Description

Three phase Inverters convert DC power from the photovoltaic (PV) array into alternating current (AC) power that can satisfy local loads as well as feed the power distribution grid.

This manual covers the three phase inverter models listed below:

S6-GC25K-US, S6-GC33K-US, S6-GC36K-US, S6-GC40K-US, S6-GC50K-US, S6-GC60K-US. S6-GC30K-LV-US

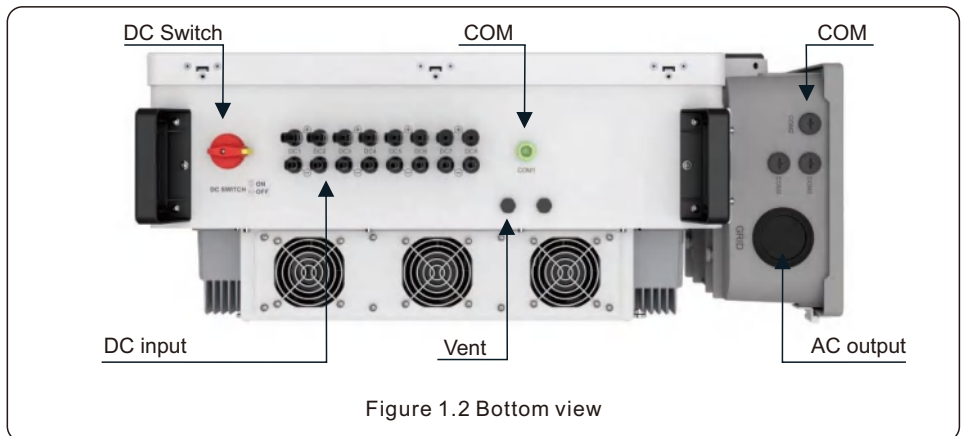
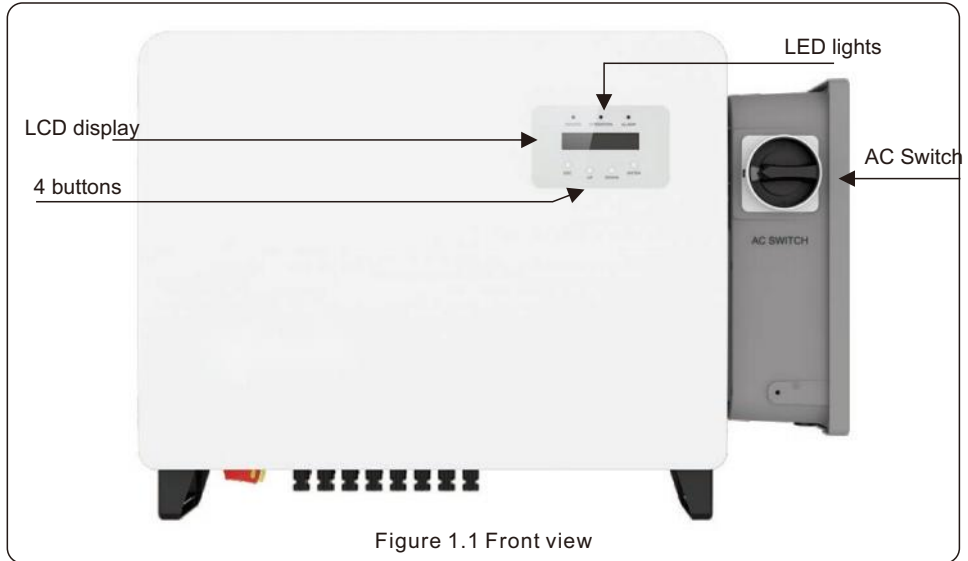

1.2 Front Panel Display

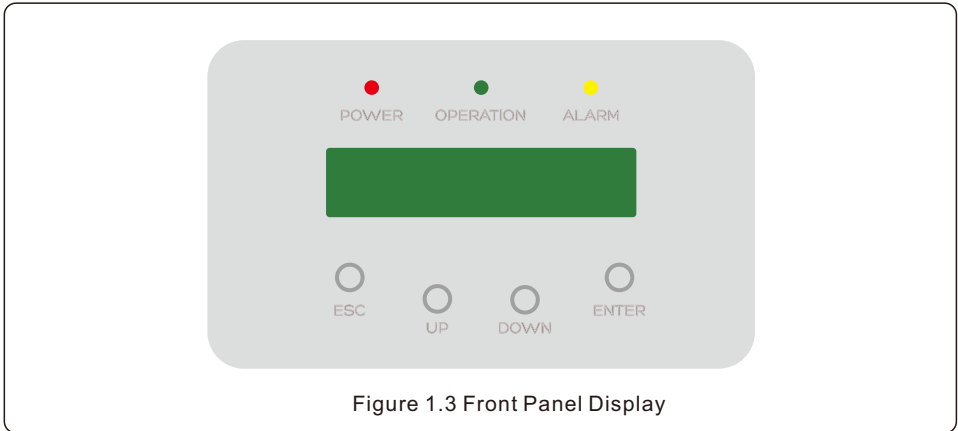

Figure 1.3 Front Panel Display

1.3 LED Status Indicator Lights

There are three LED status indicator lights in the front panel of the inverter.

- POWER LED (red) indicates the power status of the inverter.
- OPERATION LED (green) indicates the operation status.
- ALARM LED (yellow) indicates the alarm status.

Light	Status	Description
● POWER	ON	The inverter detects DC power.
	OFF	No DC power or low DC power.
● OPERATION	ON	The inverter is operating properly.
	OFF	The inverter has stopped producing power.
	FLASHING	The inverter is initializing Updating software
● ALARM	ON	Alarm or fault condition is detected.
	OFF	No fault or alarm is detected.

Figure 1.4 Status Indicator LED

1.4 Unpacking

The inverter ships with all accessories in one carton.

When unpacking, please verify all the parts listed below are included:

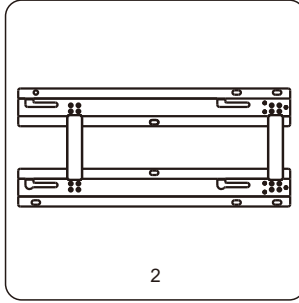

Part #	Description	Quantity	Remarks
1	Inverter	1	
2	Mounting bracket	1	
3	Fastening screw	2	Hex bolt M6*12
4	DC connector	12 for 25K-40K 16 for 50K-60K	Staubli Electrical Connectors AG PV-KBT4-EVO 2/6I-UR PV-KST4-EVO 2/6I-UR
5-1	Hex bolt	4	Hex bolt M10*40
5-2	Hex nut	4	
5-3	Washer & Lock Washer	4	

Inverter packing list

1.5 Inverter Circuit Diagram

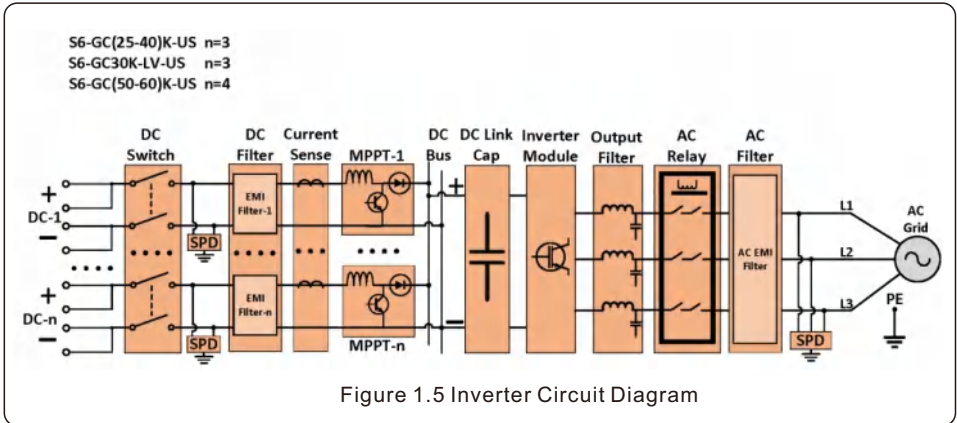

1.6 Tools Required for Installation

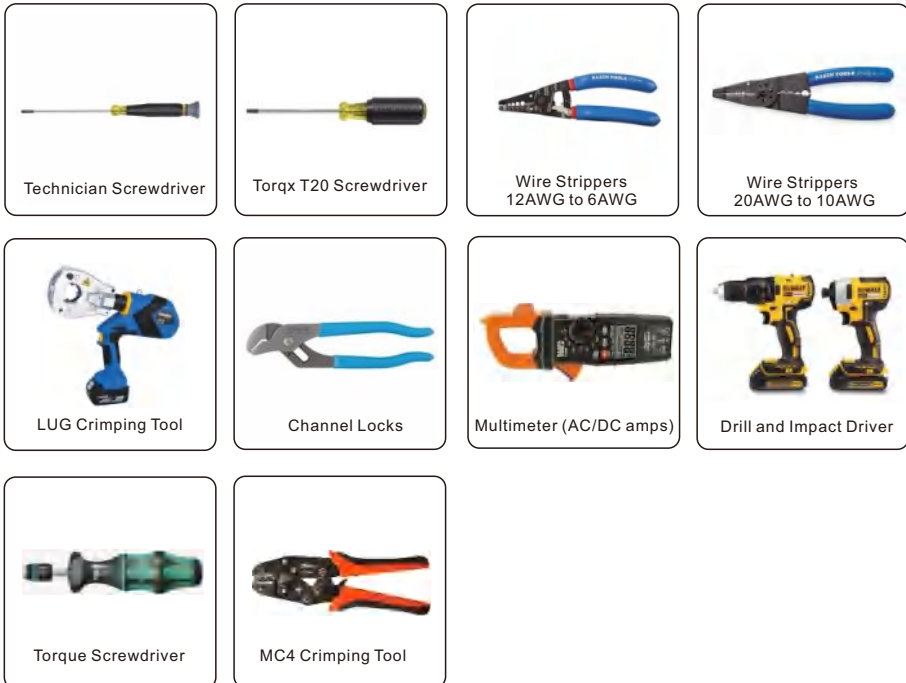

1.7 Storage

If the inverter is not installed immediately, storage instructions and environmental conditions are listed below:

- Use the original box to repackage the inverter, seal with adhesive tape with the desiccant inside the box.
- Store the inverter in a clean and dry place, free of dust and dirt. The storage temperature must be between -40~158°F and humidity should be between 0 to 100%, non-condensing.
- Do not stack more than two (2) inverters high on a single pallet. Do not stack more than 2 pallets high.
- Keep the box(es) away from corrosive materials to avoid damage to the inverter enclosure.
- Inspect the packaging regularly. If packaging is damaged (wet, pest damages, etc.), repackage the inverter immediately.
- Store inverters on a flat, hard surface -- not inclined or upside down.
- After 100 days of storage, the inverter and carton must be inspected for physical damage before installing. If stored for more than 1 year, the inverter needs to be fully examined and tested by qualified service or electrical personnel before using.
- Restarting after a long period of non-use requires the equipment be inspected and, in some cases, the removal of oxidation and dust that has settled inside the equipment will be required.



**DO NOT STACK
MORE THAN 2 HIGH**

1.8 Notice for Disposal

This product shall not be disposed of with household waste. They should be segregated and brought to an appropriate collection point to enable recycling and avoid potential impacts on the environment and human health. Local rules in waste management shall be respected .

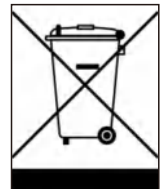

SAVE THESE INSTRUCTIONS – This manual contains important instructions for Models S6-GC25K-US, S6-GC33K-US, S6-GC36K-US, S6-GC40K-US, S6-GC50K-US, S6-GC60K-US S6-GC30K-LV-US that shall be followed during installation and maintenance of the inverter.

2.1 Safety symbols

Safety symbols used in this manual, which highlight potential safety risks and important safety information, are listed below:



WARNING

Symbol indicates important safety instructions, which if not correctly followed, could result in serious injury or death.



NOTE

Symbol indicates important safety instructions, which if not correctly followed, could result in damage to or the destruction of the inverter.



CAUTION, RISK OF ELECTRIC SHOCK

Symbol indicates important safety instructions, which if not correctly followed, could result in electric shock



CAUTION, HOT SURFACE

Symbol indicates safety instructions, which if not correctly followed, could result in burns.

2.2 General safety instructions



WARNING

Do not connect PV array positive (+) or negative (-) to ground – doing so could cause serious damage to the inverter.



WARNING

Electrical installations must be done in accordance with local and national electrical safety standards.



WARNING

To reduce the risk of fire, branch circuit over-current protective devices (OCPD) are required for circuits connected to the Inverter.



CAUTION

The PV array (solar panels) supplies a DC voltage when exposed to light.



CAUTION

The inverter's surface temperature can reach up to 75°C (167°F). To avoid risk of burns, do not touch the surface when the inverter is operating. Inverter must be installed out of the reach of children.



WARNING

The inverter can only accept a PV array as a DC input. Using any other type of DC source could damage the inverter.



CAUTION

Risk of electric shock from energy stored in the inverter's capacitors. Do not remove cover until five (5) minutes after disconnecting all sources of supply have passed, and this can only be done by a service technician. The warranty may be voided if any unauthorized removal of cover occurs.

2.3 Notice for use

The inverter has been constructed according to applicable safety and technical guidelines. Use the inverter in installations that meet the following requirements ONLY:

- 1). The inverter must be permanently installed.
- 2). The electrical installation must meet all the applicable regulations and standards.
- 3). The inverter must be installed according to the instructions stated in this manual.
- 4). The system design must meet inverter specifications.

To start-up the inverter, the Grid Supply Main Switch (AC) must be turned on, BEFORE the DC Switch is turned on. To stop the inverter, see power down instructions on page 40 Section 6.2.

2.4 Protection Circuitry and Controls

To meet relevant codes and standards, the Solis U.S. three phase inverter line is equipped with protective circuitry and controls. These include Arc Fault Circuit Interrupter (AFCI) and Anti-Islanding Protection.

Arc Fault Circuit Interrupter AFCI:

Edition 2011 of the National Electrical Code®, Section 690.11, requires that all PV plants attached to a building are fitted with a means of detecting and interrupting serial electric arcs in the PV wiring and array. An electric arc with a power of 300W or greater must be interrupted by the AFCI in the time specified by UL 1699B. A triggered AFCI fault may only be reset manually. After clearing the source of the fault, the AFCI can be deactivated via the inverter front panel interface.

Anti-Islanding Protection:

Anti-Islanding is a condition where the inverter ceases to produce power when the grid is not present. Circuitry, along with firmware, has been designed to determine if the grid is present by adjusting the output frequency of the inverter. In the case of a 60Hz resonant system where the inverter is partially isolated from the grid, the inverter programming can detect if there is a resonant condition or if the grid is actually present. It can also differentiate between inverter's operating in parallel and the grid.



NOTE

For additional installation details, watch the installation video in the link below <https://youtu.be/nkYMf-ouklw>

3.1 Environmental considerations

3.1.1 Location selection for the inverter

When selecting a location for the inverter, consider the following:



WARNING: Risk of fire

Despite careful construction, electrical devices can cause fires.

- Do not install the inverter in areas containing highly flammable materials or gases.
- Do not install the inverter in potentially explosive atmospheres.



CAUTION, HOT SURFACE

- The temperature of the inverter heat-sink can reach 167°F.

- The ambient temperature and relative humidity should meet the following requirements.

Maximum Temperature



140°F
60°C

Minimum Temperature



-13°F
-25°C

Max. Relative Humidity



100%
Non-Condensing

Maximum Altitude



13,123 feet
4,000 meters

- The load bearing structure shall meet the following requirements.



Made of non-inflammable materials



Max. load bearing capacity ≥ 4 times of inverter weight



- If multiple inverters are installed on site, a minimum clearance shall be kept according to Figure 3.1 and 3.2 .
- The LED status indicator lights and the LCD located on the inverter's front panel should not be blocked.
- Adequate ventilation must be present if the inverter is to be installed in a confined space.

3.1.1.1 Examples of correct and incorrect installations

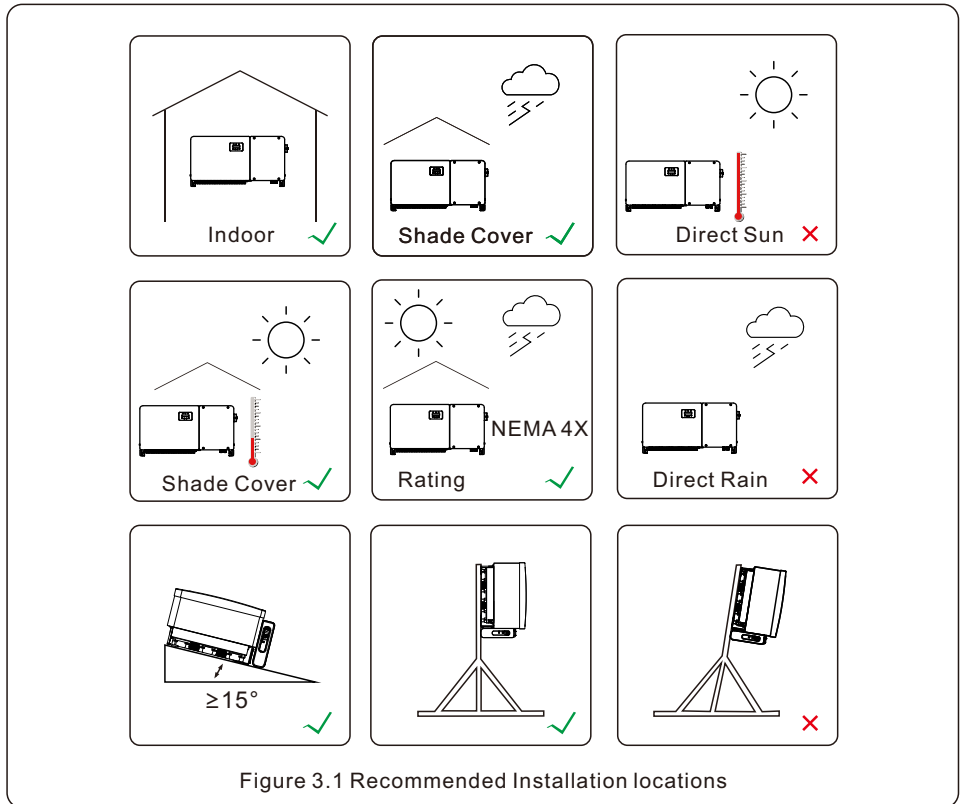

3.1.2 Other environmental considerations

3.1.2.1 Consult technical data

Consult the specifications section (section 9) for additional environmental conditions (protection rating, temperature, humidity, altitude, etc.).

3.1.2.2 Horizontal installation

For horizontal installation, this model of Solis inverter should be mounted upward in more than 15 degrees of the horizontal plane.

3.1.2.3 Vertical wall installation

For vertical installation, this model of Solis inverter should be mounted 90 degrees or backwards in less than or equal to 15 degrees.

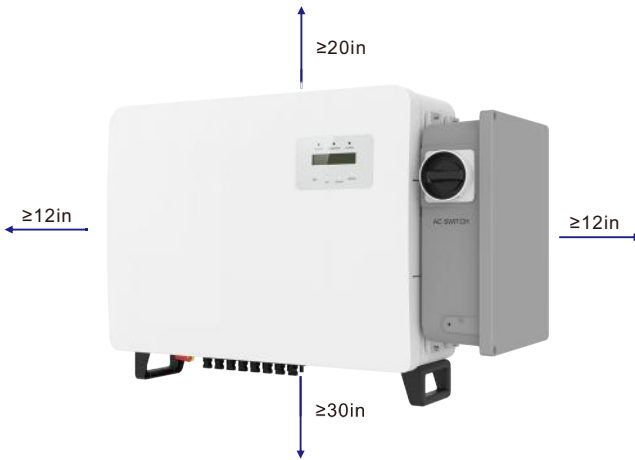

Figure 3.2 Clearance distances requirement for the inverter

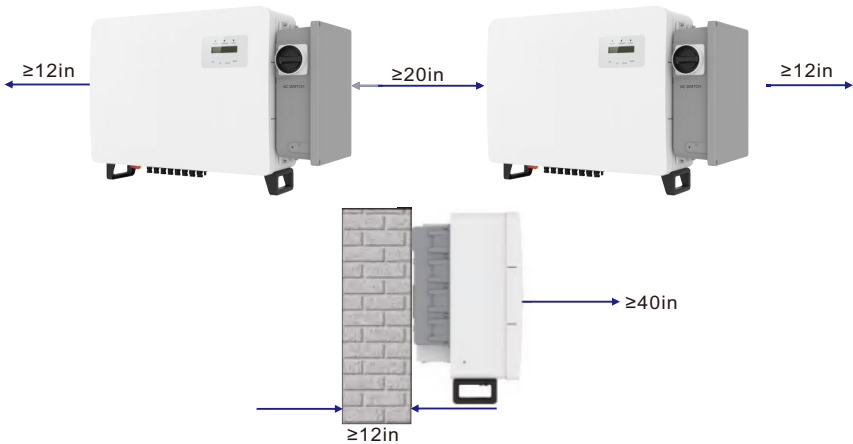

Figure 3.3 Distances required between inverters when multiple inverters are installed



NOTE

Nothing should be stored on or placed against the inverter.

3.1.2.4 Avoiding direct sunlight

Installation of the inverter in a location exposed to direct sunlight should be avoided.

Sun Shade covers are available from Solis for various inverter models.

Direct exposure to sunlight could cause:

- Power output limitation (with a resulting decreased energy production by the system).
- Premature wear of the electrical/electromechanical components.
- Premature wear of the mechanical components (gaskets) and user interface.

3.1.2.5 Air circulation

Do not install in small, closed rooms where air cannot freely circulate. To prevent overheating, always ensure that the air flow around the inverter is not blocked.

3.1.2.6 Flammable substances

Do not install near flammable substances. Maintain a minimum distance of three (3) meters (10 feet) from such substances.

3.1.2.7 Living area

Do not install in a living area where the prolonged presence of people or animals is expected. Depending on where the inverter is installed (for example: the type of surface around the inverter, the general properties of the room, etc.) and the quality of the electricity supply, the sound level from the inverter can be quite high.

3.2 Product handling

Please review the instruction below for handling the inverter:

1. The red circles below denote cutouts on the product package.

Push in the cutouts to form handles for moving the inverter (see Figure 3.4).

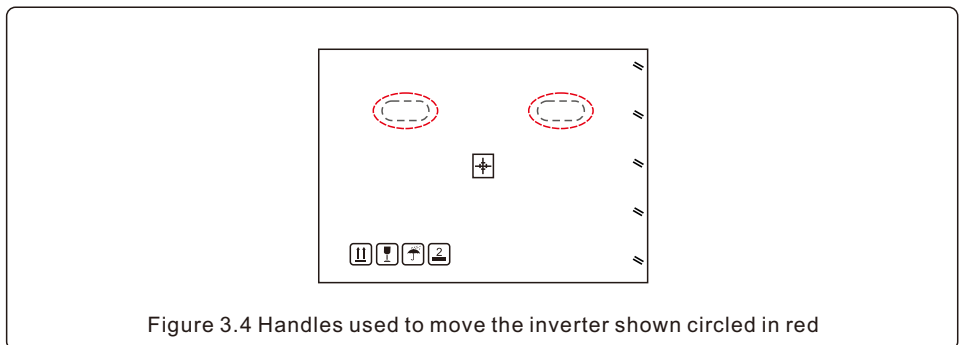

Figure 3.4 Handles used to move the inverter shown circled in red

2. Two people are required to remove the inverter from the shipping box. Use the handles integrated into the heat sink to remove the inverter from the carton (see Figure 3.5).

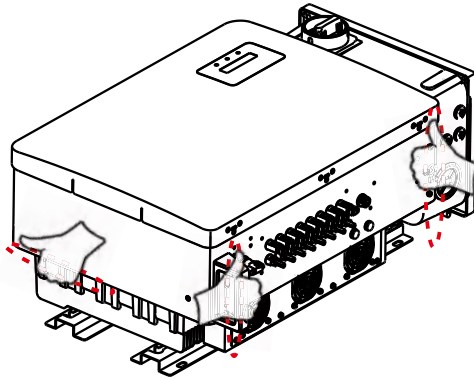

Figure 3.5 Inverter lifting method



WARNING

Due to the weight of the inverter, contusions or bone fractures could occur when incorrectly lifting and mounting the inverter. When mounting the inverter, take the weight of the inverter into consideration. Use a suitable lifting technique when mounting. Requires minimum of two people to lift or hoist the inverter in place.

3.3 Mounting the Inverter

The inverter can be mounted to the wall or metal array racking. The mounting holes should be consistent with the size of the bracket or the dimensions shown in Figure 3.6.

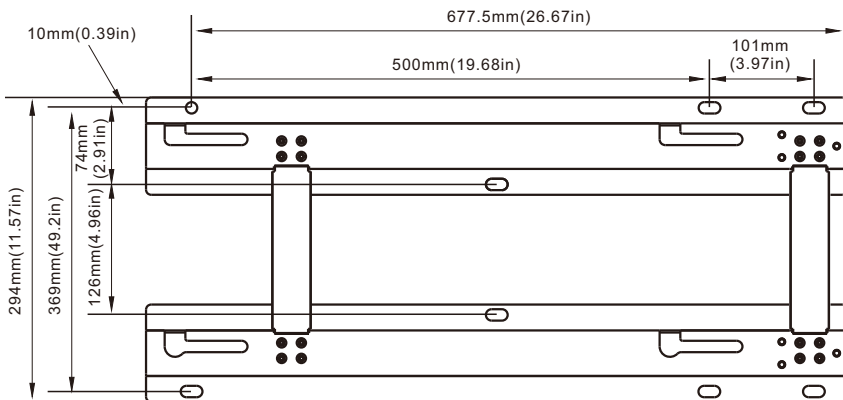
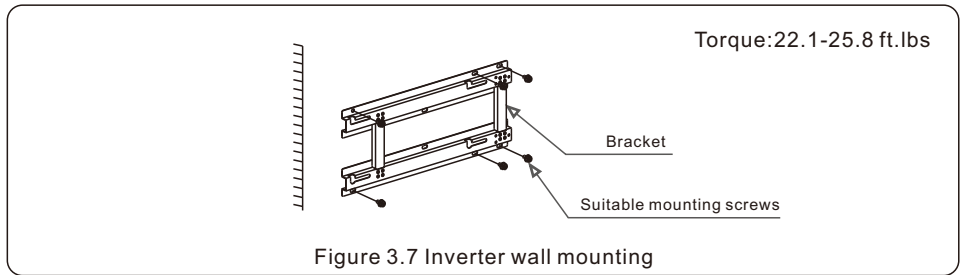

Figure 3.6 Inverter wall mounting

3.3.1 Wall mounting

1. Use the suitable mounting screws to attach the bracket on the wall.



2. Take off the Protective cover on the back of AC wiring box.

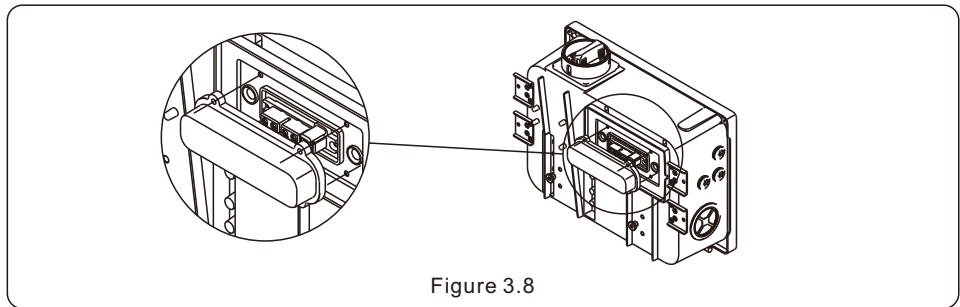

3. Take off the Protective cover in the side of inverter.

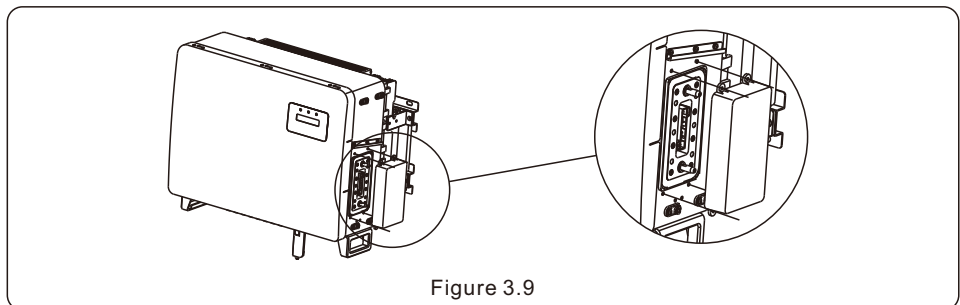

4. Use the Connecting plate with screws to fix the AC wiring box on the bracket.

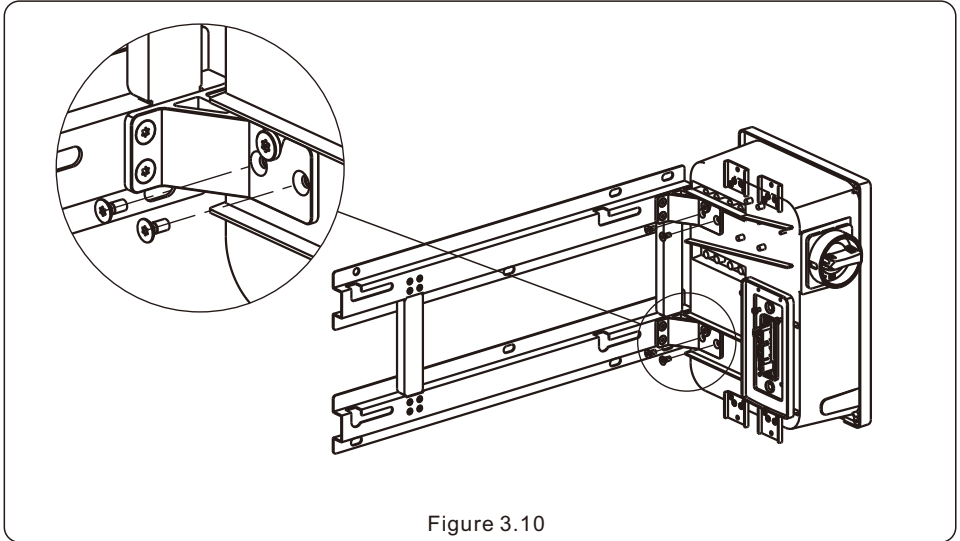

Figure 3.10

5. Lift the inverter and hang it on the bracket, and slide down to make sure they match perfectly. Finally push the inverter to match the AC wiring box.

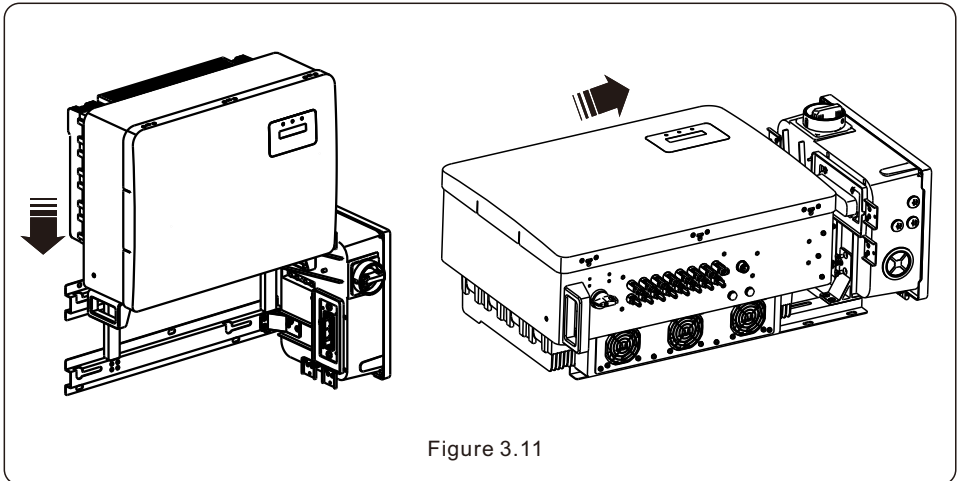

Figure 3.11

6. Fix the AC wiring box to the inverter by screws.

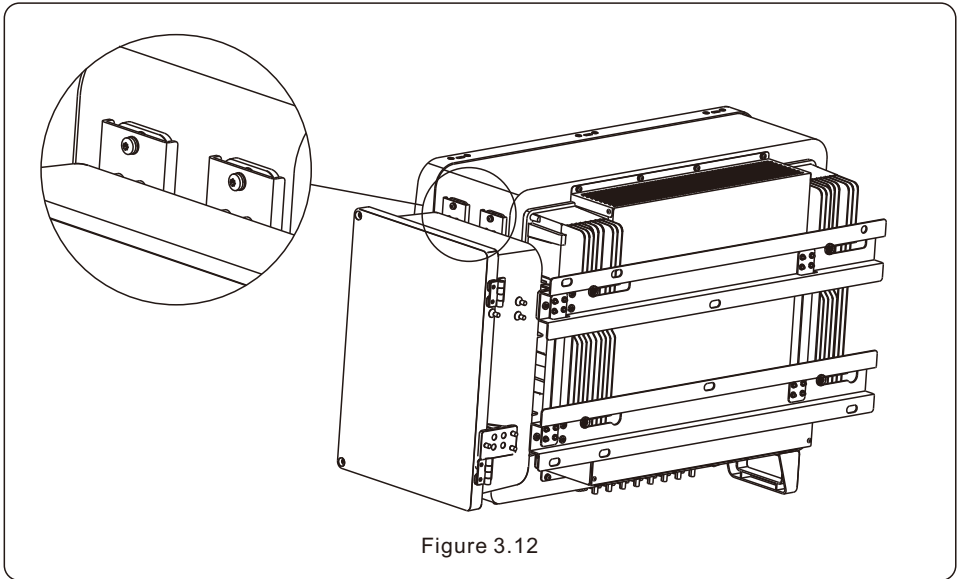

Figure 3.12

3.3.2 Rack mounting

The steps to mounting to the rack are listed below:

1. Select a location for the inverter

- With a Type 4X protection rating, the inverter can be installed both outdoors and indoors.
- When the inverter is running, the temperature of the chassis and heat sink will be higher than the ambient . Do not install the inverter in a location that you could accidentally touch.
- Do not install the inverter where flammable or explosive materials are stored.

2. Installation angle

Install inverter as shown in Figure 3.13 below.

Install the inverter vertically. If the inverter cannot be mounted vertically, it may be mounted at angles greater than 15 degrees off horizontal. Inverter cannot be mounted flat.

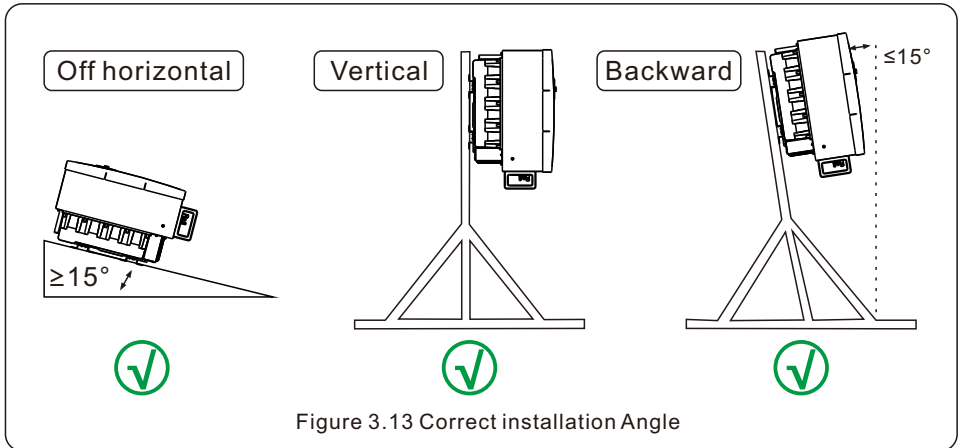

Figure 3.13 Correct installation Angle

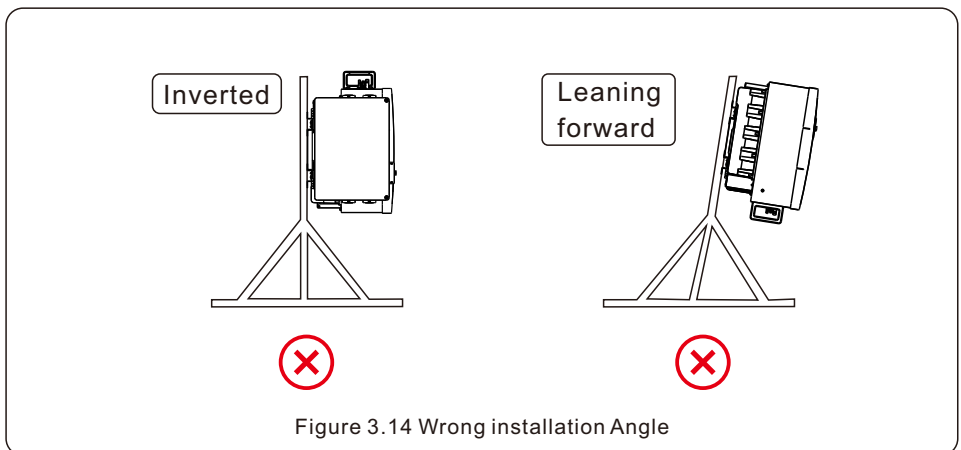

Figure 3.14 Wrong installation Angle

3. Install mounting plate

a. Remove the bracket and fasteners from the packaging. Mark the position for hole drilling according to the hole positions of the bracket.

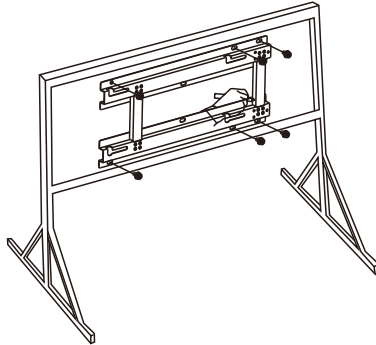

Figure 3.15 Mark the position for hole

b. Drill the marked holes. It is recommended to apply anti-corrosive paint at the hole for corrosion protection.

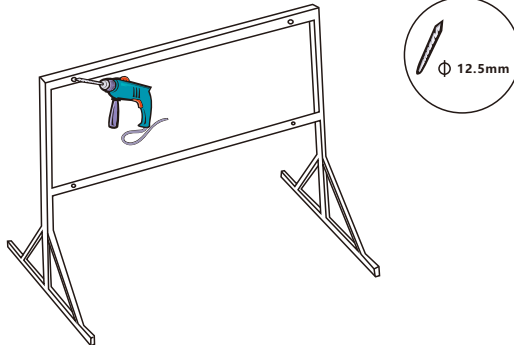

Figure 3.16 Drill hole

c. Align the mounting plate with the holes, Insert the combination bolt (M10X40) through the mounting plate into the hole. Secure the bracket to the metal frame firmly with the supplied fastener. Torque the nut to 25.8 ft.lbs.

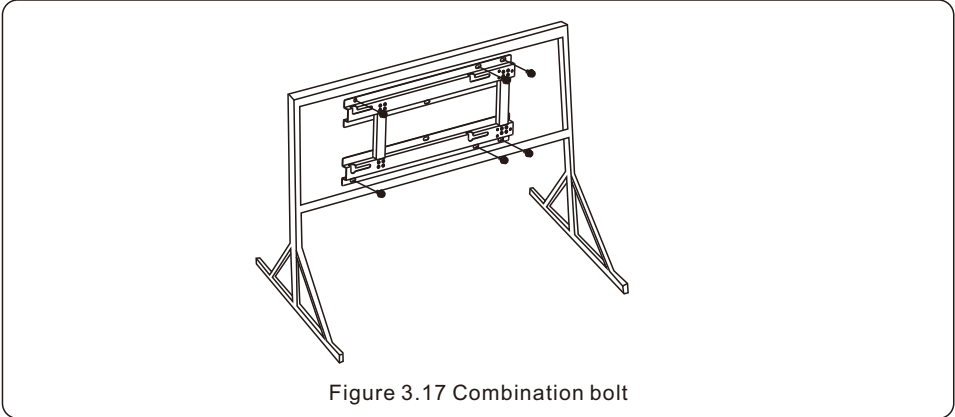

Figure 3.17 Combination bolt

d. Install the inverter as described in figures 3.8-3.12

3.4 Electrical Connections

Inverter design uses PV style quick-connect terminal. The inverter cover shall not be opened during DC electrical connection. The labels located on the bottom of the inverter are described below in table 3.1. All electrical connections must be in accordance with local and/or national standard.

Parts	Connection	Cable size	Torque
DC terminal	PV strings	12-8 AWG	NA
Ground terminal External	Equipment Ground	Local Code	4.4-6.0 ft.lbs
Ground terminal Internal	AC ground	4-3/0 AWG (Max 250MCM)	11-15 ft.lbs
Grid terminal	Grid	4-3/0 AWG (Max 250MCM)	11-15 ft.lbs
RS-485 terminal	Communication cable	22-12 AWG	0.44 ft.lbs
RJ45 terminal	Communication cable	Network cable	NA
COM terminal	Wi-Fi/Cellular stick	NA	NA

Table 3.1 Electrical connections

The electrical connection of the inverter must follow the steps listed below:

1. Switch the Grid Supply Main Switch (AC) OFF and LOTO the Main Switch.
2. Switch the DC Switch to OFF position.
3. Connect the inverter to the grid.
4. Assemble PV connector and connect to the Inverter.

3.4.1 Grounding

The inverter must be grounded for safety. Two methods are provided.

1. Connect the AC grounding cable. (See Section 3.4.3)
2. Connect the equipment grounding terminal on the heatsink described below.

To connect the grounding terminal on the heat sink, please follow the steps below:

1. It is recommended to use copper wire for the chassis ground. Either solid conductor or stranded wire is acceptable. Refer to local code standard for wire sizing.
2. Attach OT terminal: M10.



NOTE

For multiple inverters in parallel, all inverters should be connected to the same ground point to eliminate the possibility of a voltage potential existing between inverter grounds.

3. Strip the ground cable insulation to a suitable length. (see Figure 3.18)

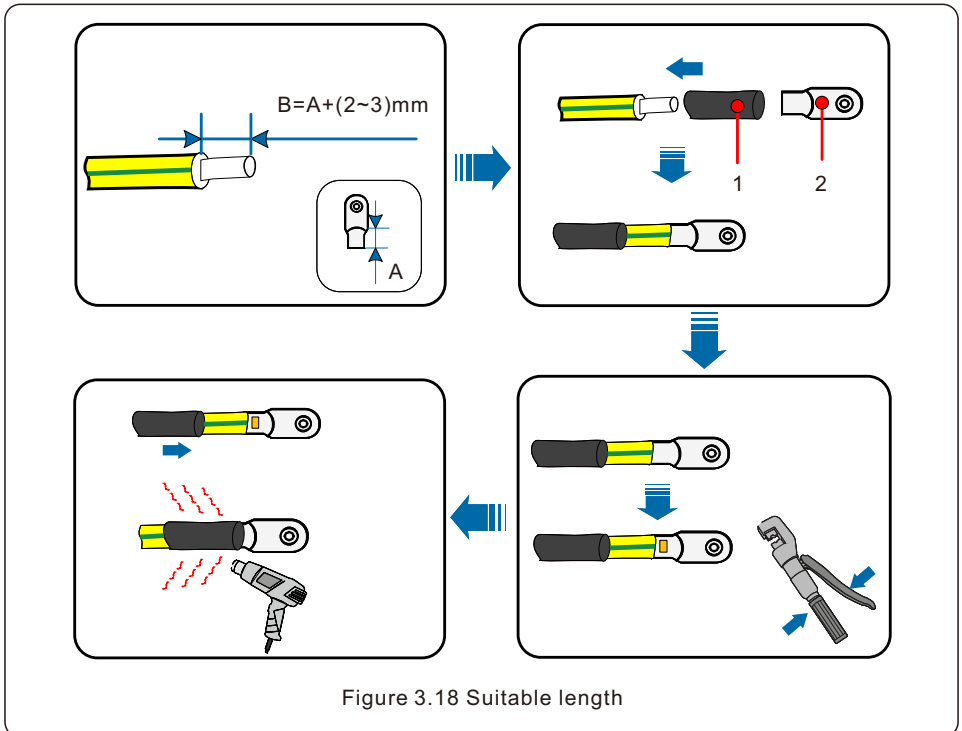



NOTE

B (insulation stripping length) is 2mm-3mm longer than A (OT cable terminal crimping area).

4. Insert the stripped wire into the OT terminal crimping area and crimp with a hydraulic crimp tool. (see Figure 3.18)



NOTE

After crimping the terminal to the wire, inspect the connection to ensure the terminal is solidly crimped to the wire.

5. Remove the M10 screw from the heat sink ground point.

6. Connect the grounding cable to the grounding point on the heat sink, and tighten the grounding screw, Torque is 4.4-6.0 ft.lbs. (see figure 3.19)

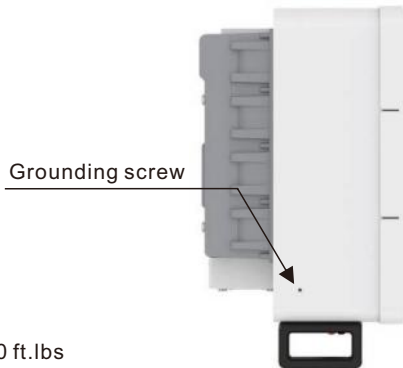

Torque: 4.6-6.0 ft.lbs

Figure 3.19 Fixed cable



NOTE

To reduce corrosion, apply silicone or paint to the screw after ground cable has been installed.

3.4.2 Connect PV side of inverter



WARNING

Before connecting the inverter, make sure the PV array open circuit voltage is within the limit of the inverter. Otherwise, the inverter could be damaged.



WARNING

DO NOT connect the PV array positive or PV array negative cable to ground. This can cause serious damage to the inverter!



WARNING

MAKE SURE the polarity of the PV array output conductors matches the DC- and DC+ terminal labels before connecting these conductors to the terminals of the inverter.



WARNING

Please use the original DC MC4 terminals, otherwise the unqualified DC connectors may cause damages to the inverter.

Please see table 3.1 for acceptable wire size for DC connections. Wire must be copper only.

The steps to assemble the DC connectors are listed as follows:

1. Strip off the DC wire for about 7mm, Disassemble the connector cap nut.
2. Insert the wire into the connector cap nut and contact pin.

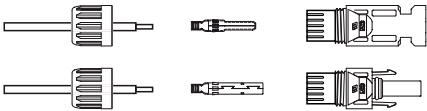

Figure 3.20 Disassemble the Connector Cap nut

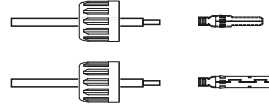

Figure 3.21 Insert the Wire into the Connector Cap nut and contact pin

3. Crimp the contact pin to the wire using a proper wire crimper.
4. Insert metal connector into top of connector, and tighten nut with torque 3-4 Nm.

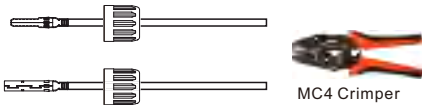

Figure 3.22 Crimp the contact pin to the wire



Figure 3.23 Connector with Cap nut Screwed on

5. Measure PV voltage of DC input with multimeter, verify DC input cable polarity (see figure 3.24), and ensure each string voltage is in range of inverter operation.
6. Connect DC connector with inverter until hearing a slight clicking sound indicating successful connection. (see figure 3.25)

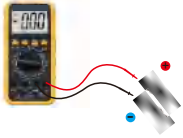

Figure 3.24 Multimeter measurement



Figure 3.25 Connect the DC Connectors to the Inverter

Cable type	Traverse area (mm ²)		Outside diameter of cable (mm)
	Range	Recommended value	
PV Wire UL 4703 Listed	4.0~6.0 (12~10AWG)	4.0 (12AWG)	5.5~9.0



Caution

If DC inputs are accidentally reversely connected or inverter is faulty or not working properly, it is NOT recommended to turn off the DC switch under Normal operating condition and only under Emergency operating conditions the switch can be used to turn OFF the DC inputs and disconnect PV strings. Under Normal operating condition the proper actions are:

- Use a clip-on amp-meter to measure the DC string current.
- If it is above 0.5A, please wait for the solar irradiance to drop until the current decreases to below 0.5A.
- Only after the current is below 0.5A, you are allowed to turn off the DC switches and disconnect the PV strings.

Requirements for the PV modules per MPPT input:

- All PV modules must be of the same type and power rating.
- All PV modules must be aligned and tilted identically.
- The open-circuit voltage of the PV array must never exceed the maximum input voltage of the inverter, even at the coldest expected temperature. (see section 9 “Specifications” for input current and voltage requirements)
- Each string connected to a single MPPT must consist of the same number of series-connected PV modules.
- Short circuit current of all strings connected to a single MPPT must not exceed the Max. Short Circuit rating of the MPPT input. (see section 9 “Specifications” for Max. Short Circuit Current specification) .

3.4.2.1 DC connection high voltage danger notice



CAUTION
RISK OF ELECTRIC SHOCK

Do not touch an energized DC conductor. There is high voltages present when PV modules are exposed to light causing a risk of death due to an electric shock from touching DC conductors!

Only connect the DC cables from the PV module to the inverter as described in this manual.



CAUTION
POTENTIAL DAMAGE TO THE INVERTER DUE TO OVERVOLTAGE

The DC input voltage of the PV modules must not exceed the maximum rating of the inverter. (see Section 9 “Specifications”)

Check the polarity and the open-circuit voltage of the PV strings before connecting the DC cables to the inverter.

Confirm proper string length and voltage range before connecting DC cable to the inverter.

3.4.3 Connect grid side of inverter



WARNING
An over-current protection device must be used between the inverter and the grid.

1. Connect the three (3) AC conductors to the three (3) AC terminals marked “L1”, “L2” and “L3”. Neutral connection marked “N” is option connection terminal and is NOT required for inverter operation. Refer to local code and voltage drop tables to determine the appropriate wire size and type.
2. Connect the grounding conductor to the terminal marked “PE” (protective earth, the ground terminal).



NOTE
The AC output neutral is not bounded to the ground.
The neutral wire is not necessary for the installation.

Over-Current Protection Device (OCPD) for the AC side

To protect the inverter's AC connection line, we recommend installing a device for protection against over-current and leakage, with the following characteristics noted in Table 3.2 (The OCPD shall comply with National Electrical Code®, ANSI/NFPA 70 or the Canadian Electrical Code® CSA C22.1):

3.4.3.1 Aluminum Cable Requirements

When Aluminum cable is selected, use copper to aluminum adapter terminal to avoid direct contact between the copper bar and the aluminum cable. Direct contact between the copper bar and aluminum cable will cause electro mechanical corrosion and impair the reliability of the electrical connection. When using aluminum/copper wire rated lug, no additional adapters are required.

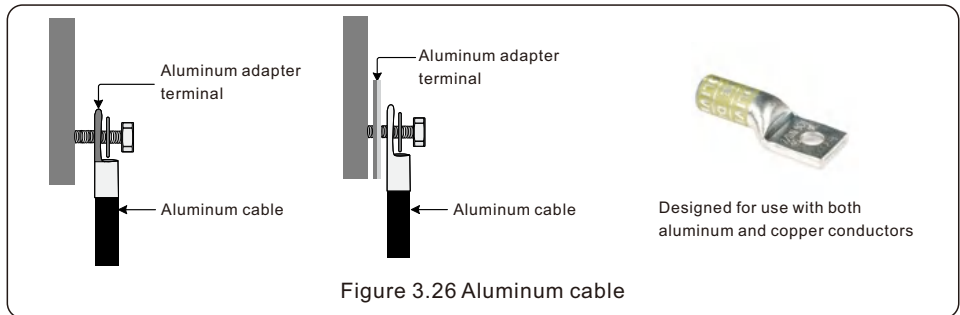

Figure 3.26 Aluminum cable



NOTE

Inverter OCPD must be selected in accordance with National Electrical Code® ANSI/NFPA 70 or the Canadian Electrical Code® CSA C22.1. Operating ambient temperature and humidity must be factored and considered when selecting OCPD for the inverter output.

Inverter	Rated voltage(Vac)	Max. output current (Amps)	Recommended current range for OCPD (A)
S6-GC25K-US	480	30.1	40
S6-GC33K-US	480	39.7	50-60
S6-GC36K-US	480	43.3	60
S6-GC40K-US	480	48.1	65-70
S6-GC50K-US	480	60.1	80-90
S6-GC60K-US	480	72.2	100
S6-GC30K-LV-US	208	83.3	120

Table 3.2 Rating of grid OCPD

3.4.3.2 Wiring procedure

All electrical installations must be carried out in accordance with the local standards and the National Electrical Code® ANSI/NFPA 70 or the Canadian Electrical Code® CSA C22.1. The AC and DC electric circuits are isolated from the enclosure. If required by section 250 of the National Electrical Code®, ANSI/NFPA 70, the installer is responsible for grounding the system.

The grid voltage must be within the permissible range. The exact operating range of the inverter is specified in Section 9 “Specifications”.

3.4.3.2 Wiring procedure



CAUTION

RISK OF ELECTRIC SHOCK. Prior to starting the wiring procedure, ensure that the three-pole circuit breaker is switched off and are LOTO.



NOTE

Damage or destruction of the inverter's electronic components due to moisture and dust intrusion will occur if the enclosure opening is enlarged.



CAUTION

Risk of fire if two conductors are connected to one terminal. If a connection of two conductors to a terminal is made, a fire can occur. NEVER CONNECT MORE THAN ONE CONDUCTOR PER TERMINAL.



NOTE

Use M10 crimp terminals to connect to the inverter AC terminals.

Cable specification		AC Phase L1-L3 wire	Ground wire
Conductor gage AWG/ (mm ²)	Range	4- 250kcmil (21~120)	4-250kcmil (21~120)
Conduit diameter Inch/ (mm)	Size	2" (62)	Same Conduit



NOTE

Cable ampacity of ground wire should be more than half of cable ampacity of AC phase L1,L2,L3 wire.

The steps to assemble the AC grid terminals are listed as follows:

1. Strip the end of AC cable insulating jacket about 11.8 inch then strip the end of each wire.

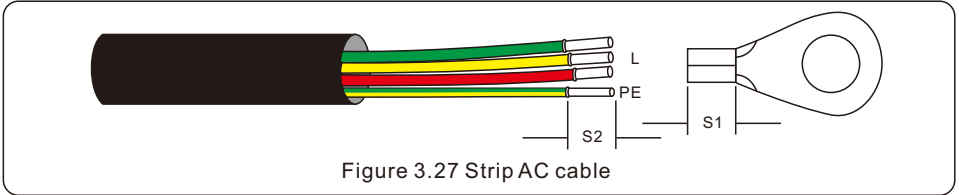

Figure 3.27 Strip AC cable



NOTE

S2 (insulation stripping length) is 2mm-3mm longer than S1.
(OT cable terminal crimping area)

2. Strip the insulation of the wire past the cable crimping area of the OT terminal, then use a hydraulic crimp tool to crimp the terminal. The crimped portion of the terminal must be insulated with heat shrinkable tube or insulating tape.

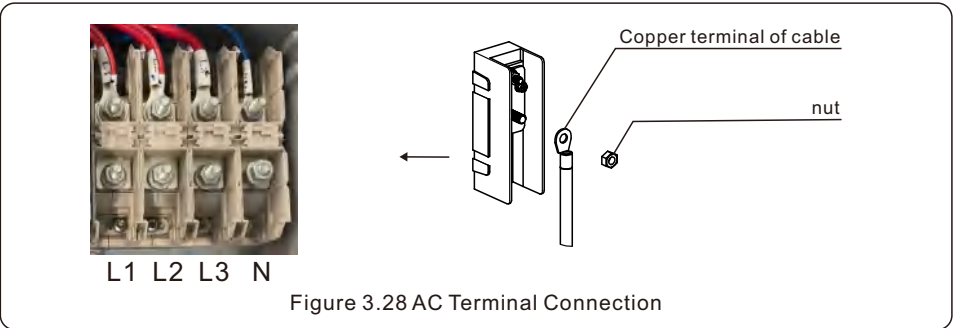

Figure 3.28 AC Terminal Connection



WARNING

Installer must use manufacturer approved crimping tools and crimping guide for proper connector installation. Improper crimping of the connector will void inverter warranty.

When making multiple crimps, make the first crimp nearest the tongue and work towards the barrel end.

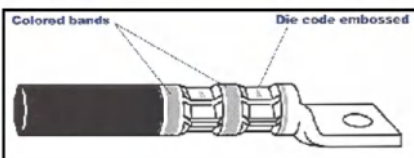

When crimped, the die code number or other marking will be embossed on the connector for easy inspection to determine if correct die and connector combination were used

- 3. LOTO the AC breaker disconnect to ensure it does not close unexpectedly.
- 4. Remove the 2 screws on the inverter junction box and remove the junction box cover. (See figure 3.29)

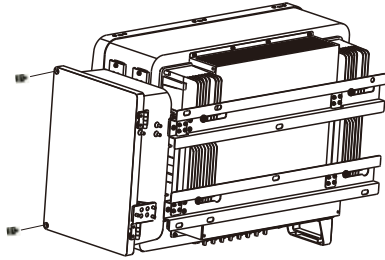
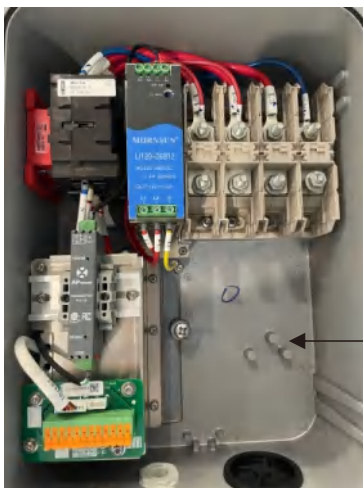

Figure 3.29 Remove the junction box cover

- 5. Insert the cable through the nut, sheath and AC terminal cover. If using conduit, remove plastic nut to expose hole for conduit connection. Connect the cable to the terminal block. Tighten the nuts on the terminal block to 11-15 ft-lbs. (See figure 3.28)



L1 L2 L3 N

Figure 3.30 wiring

4.1 RS485 Communication

The inverter package will include a 12-Pin connector.

The Pin definition is shown below. Facing the connector, Pin 1 is on the left of the first row. The rest polarity is showing in below diagram.

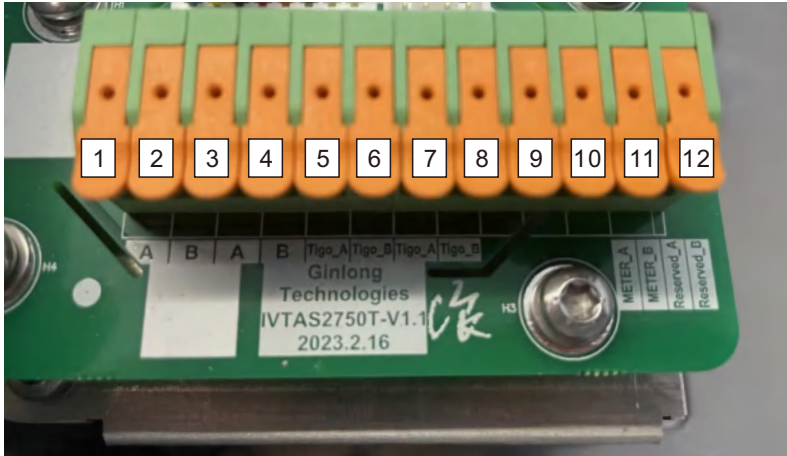

PIN	Definition	Description
1	RS485	RS485 A IN
2		RS485 B IN
3		RS485 A OUT
4		RS485 B OUT
5	Transmitter (TIGO)	RS485 A IN
6		RS485 B IN
7		RS485 A OUT
8		RS485 B OUT
9	Meter	RS485 A
10		RS485 B
11	/	Reserved A
12	/	Reserved B

Figure 4.1 12-pin connector

Monitoring system for multiple inverters

Multiple inverters can be monitored through RS-485 and Ethernet daisy chain configuration.

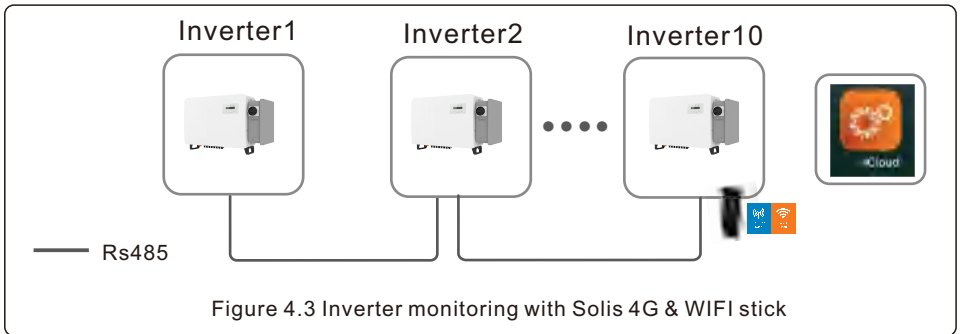
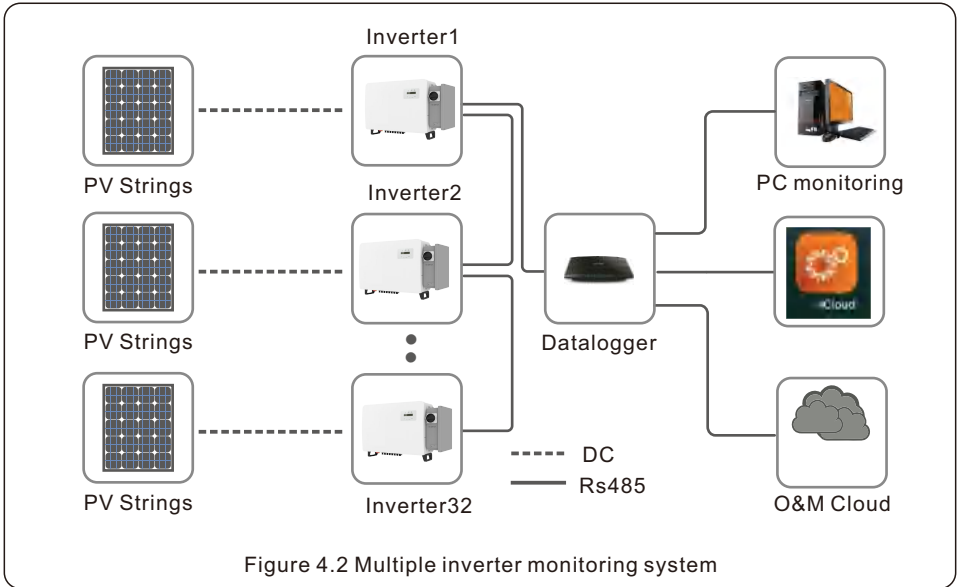

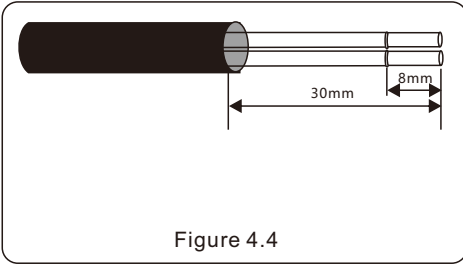

Figure 4.4

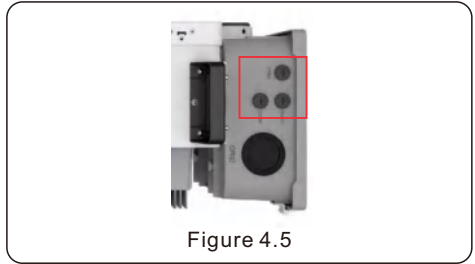



Figure 4.5

- a. Insert the cable through the cap nut for each port . COM2 (RS485 IN) COM3 (RS485 OUT).
- b. Insert the cable into the connector PIN's 1-2 for RS485 IN and PIN's 3-4 for RS485 OUT.

NOTE



Inverter can support only one master communication device. When communication device is connected to the communication port (COM) of the inverter, RS485 output port will be disabled.

NOTE





For robust RS485 communication it is recommended to use BELDEN 3106A shielded cable or equivalent. Maximum cable length \leq 4000 feet at 9600 baud rate.

NOTE

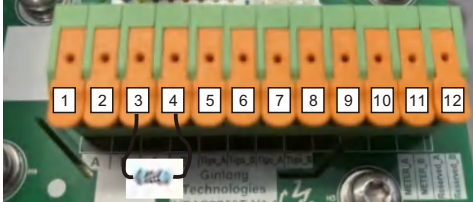

For improved noise immunity of RS485 communication it is recommended to add a 120 Ω Ohms termination resistor to the last inverter in the RS485 daisy chain. The termination resistors can be installed at RS485 OUT PORT.

5.1 Selecting the appropriate grid standard

5.1.1 Verifying grid standard for country of installation

Solis inverters are used worldwide and feature preset standards for operating on any grid. Although the grid standard is set at the factory, it is essential the grid standard be verified for the country of installation before commissioning.

The menu for changing the grid standard or for creating a custom standard is accessible as described in Section 6.7 and below.



WARNING

Failure to set the correct grid standard could result in improper operation of the inverter, inverter damage or the inverter not operating at all.

5.2 Changing the grid standard

5.2.1 Procedure to set the grid standard



NOTE

This operation is for service technicians only. The inverter is customized according to the local grid standard before shipping. There should be no requirement to set the standard.



NOTE

The "User-Def" function can only be used by the service engineer. Changing the protection level must be approved by the local utility.

1. From the main screen on the display, select **ENTER**. There are 4 sub-menu options, use the UP/DOWN arrows to highlight **ADVANCED SETTINGS**. Press enter to select.

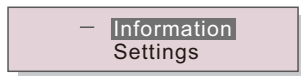

Figure 5.1

2. The screen will show that a password is required. The default password is "0010", press the DOWN key to move cursor, press the UP key to change the highlighted digit.

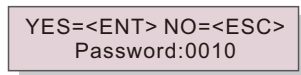

Figure 5.2

3. Use the UP/DOWN keys to highlight the **SELECT STANDARD** option. Press enter to select.

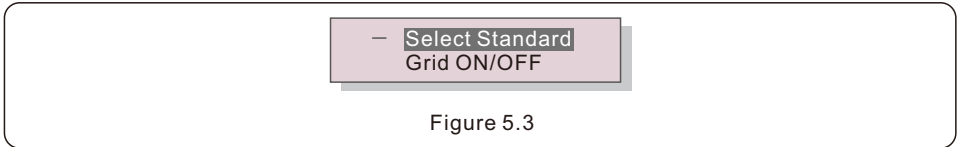

Figure 5.3

4. Select the grid standard for the country of installation.

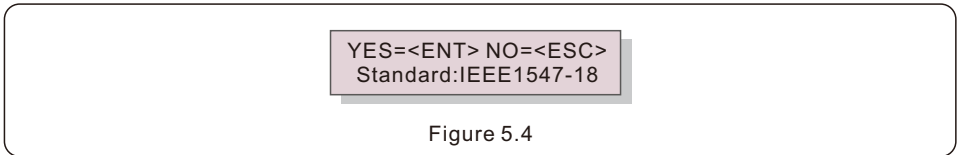

Figure 5.4

Press the UP or DOWN key to select the standard. Press the **ENTER** key to confirm the setting. Press the **ESC** key to cancel changes and return to the previous menu.

IEEE1547-18 must be selected for U.S. grid standard.

When IEEE1547-18 standard is selected, the standard complies with all the IEEE1547-2018, IEEE1547a-2020 and UL1741SB settings requirements.

5.3 Setting a custom grid standard



WARNING

- Failure to set the correct grid standard could result in improper operation of the inverter, inverter damage or the inverter not operating at all.
- Only certified personnel should set the grid standard.
- Only set the grid configuration that is approved by your location and national grid standards.

1. IEEE1547-18 Grid standard can be edited to comply with custom grid settings that are mandated by local Utilities and AHJ.

5.4 Preliminary checks



WARNING

High Voltage.

AC and DC measurements should be made only by qualified personnel.

5.4.1 DC configuration

Verify DC configuration by noting the number of panels in a string and the string voltage.

5.4.1.1 VOC and Polarity

Measure VOC, and check string polarity. Ensure both are correct and VOC is within specification.

5.4.1.1.1 Check string voltage

To measure the open circuit voltage (VOC) and polarity of the individual strings, perform the following steps:

1. Connect the positive lead of the meter to the positive string cable of the string under test.
Connect the negative lead of the meter to the negative string cable of the string under test.
2. Measure the voltage present between the positive and negative wires of each string.
If the open circuit voltage of the string is near the maximum value accepted by the inverter, verify the string length. Low ambient temperatures cause an increase in the string voltage causing potential damage to the inverter.
3. Check the polarity of the string. All digital meters have a negative (“-”) indicator that indicates when a voltage is negative; in this case a string connected in reverse polarity.



WARNING

Input voltages higher than the maximum value accepted by the inverter (see “Specifications” in Section 9) may damage the inverter.

Although Solis inverters feature reverse polarity protection, prolonged connection in reverse polarity may damage these protection circuits and/or the inverter.

5.4.1.2 Leakage to ground

Measure leakage to ground to check for a DC ground fault.

5.4.1.2.1 Detection of leakage to ground

Solis inverters are transformer-less and do not have an array connection to ground.

Any measurement of a fixed voltage between ground and either the positive or negative string wiring indicates a leakage (ground fault) to ground and must be corrected prior to energizing the inverter or damage to the inverter may result.

To measure leakage to ground, perform the following steps:

1. Ensure that neither negative nor positive DC conductors are connected to the ground strip.
2. Measure each string positive connection to ground.
3. Measure each string negative connection to ground.
4. Verify the voltage is “floating”(slowly discharging toward 0V), not a consistent voltage to ground. Make sure you notice the units of the measurement. mV is not the same as V.

5.4.2 AC configuration

Verify AC configuration.

5.4.2.1 Measure VAC and frequency

Measure VAC and verify voltage is within local grid standards.

1. Measure each phase to ground (L-G).
2. Measure phases to the other phases in pairs (L-L). PH A to PH B, PH B to PH C and PH C to PH A.
3. If the meter is equipped, measure the frequency of each phase to ground.
4. Ensure each measurement is within local grid standards and the inverter specifications as noted in Section 9 “Specifications”.

5.4.2.2 Phase rotation test

A phase rotation test is recommended to ensure the phases have been connected in the appropriate order. Solis inverters do not require a specific phase rotation connection. However, the local utility may require a specific phase rotation or a record of the phase configuration of the installation.

5.4.3 DC Connections

Verify DC connections.

Lightly tug on each DC cable to ensure it is properly connected to the inverter.

5.4.4 AC Connections

Verify AC connections.

1. Lightly tug on each AC cable to ensure it is fully captured in the terminal.
2. Visually check for any stray strands that may not be inserted in the terminal.
3. Check to ensure the terminal screws are torque to correct specification table 3.1 .

6.1 Start-up procedure

To start-up the inverter, it is mandatory that the steps below are followed in the exact order outlined.

1. Ensure the commissioning checks in Section 5 have been performed.
2. Switch the AC switch **ON**.
3. Switch the DC switches **ON** one at a time. If the PV array (DC) voltage is higher than the inverter start-up voltage, the inverter will turn on. The red **DC POWER** LED and LCD will be continuously lit.
4. Solis inverters are powered from the DC side. When the inverter detects DC voltage that is within start-up and operating ranges, the inverter will turn on. After turn-on, the inverter will check internal parameters, sense and monitor AC voltage, frequency rate and the stability of the supply grid. During this period, the green **OPERATION** LED will flash and the LCD screen will show **WAITING**. This tells the operator that the inverter is preparing to generate AC power.
5. After the locally mandated delay (300 seconds for IEEE-1547 compliant inverters), the inverter will start generating AC power. The green **OPERATION** LED will light continuously and the LCD screen will show **GENERATING**.



CAUTION

The inverter's surface temperature can reach up to 75°C (167°F). To avoid risk of burns, do not touch the surface when the inverter is in the operational mode. Additionally, the inverter must be installed out of the reach of children.

6.2 Shutdown procedure

To stop the inverter, it is mandatory that the steps below are followed in the exact order outlined

1. Press the **ENT** key to enter internal menus.
2. Navigate to **Advance Settings**.
3. Authorized Technicians will use the Password **0010** to enter the Advance Settings menu.
4. Enter the Advance Settings menu and scroll down to **Grid OFF/ON**.
5. Use the arrow keys to choose **GRID OFF**.
6. Technician will see the Green Operation LED go dark. The inverter may indicate a NO GRID alarm and the technician may see a Yellow Alarm LED illuminate. The RED Power LED will stay lit until DC power is removed.
7. Turn off the AC Switch to the OFF position.
8. Wait approximately 30 seconds and Switch the DC switch OFF.
9. Confirm all LED's switch OFF (~one (1) minute).



CAUTION

Although the inverter DC disconnect switch is in the OFF position and all the LED's are OFF, operators must wait five (5) minutes after the DC power source has been disconnected before opening the inverter cabinet. DC side capacitors can take up to five (5) minutes to dissipate all stored energy.

In normal operation, LCD screen alternatively shows inverter power and operation status (see Figure 6.1). The screen can be scrolled manually by pressing the UP/DOWN keys. Pressing the ENTER key gives access to Main Menu.

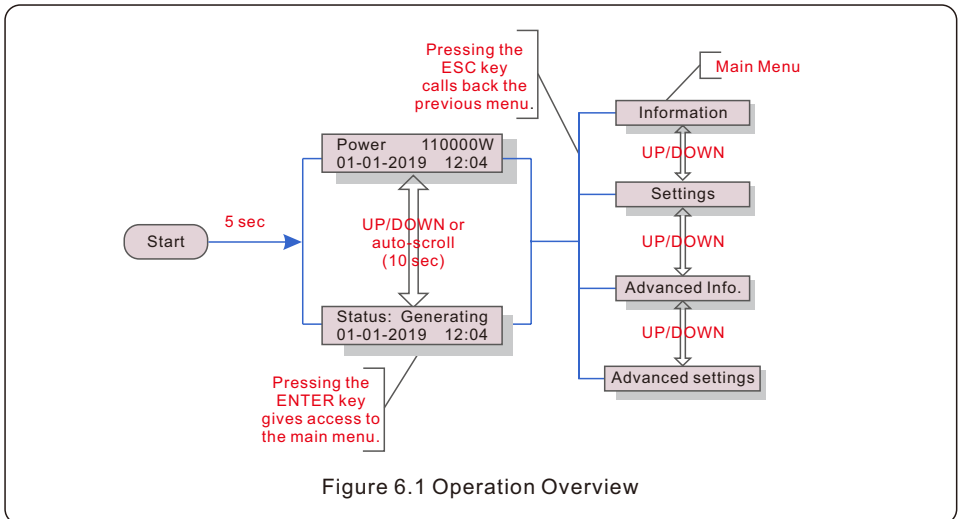

Figure 6.1 Operation Overview

6.3 Main Menu

There are four submenus in the Main Menu (see Figure 6.1):

1. Information
2. Settings
3. Advanced Info.
4. Advanced Settings

6.4 Information

The Solis three Phase Inverter main menu provides access to operational data and information. The information is displayed by selecting "Information" from the menu and then by scrolling up or down.

Display	Duration	Description
VPV_Total: 1000.0V IPV_Total: +99.0A	5 sec	VPV_Total: Shows input voltage total. IPV_Total: Shows input current total.
V_A: 345.7V I_A: 109.0A	5 sec	V_A: Shows the grid's voltage value. I_A: Shows the grid's current value.
V_C: 345.0V I_C: 109.8A	5 sec	V_C: Shows the grid's voltage value. I_C: Shows the grid's current value.
Status: Generating Power: 1488W	5 sec	Status: Shows instant status of the Inverter. Power: Shows instant output power value.
Rea_Power: 000Var App_Power: VA	5 sec	Rea_Power: Shows the reactive power of the inverter. App_Power: Shows the apparent power of the inverter.
Grid Frequency F_Grid 50.06Hz	5 sec	F_Grid: Shows the grid's frequency value.
Total Energy 0258458 kwh	5 sec	Total generated energy value.
This Month: 0123kwh Last Month: 0123kwh	5 sec	This Month: Total energy generated this month. Last Month: Total energy generated last month.
Today: 15.1kwh Yesterday: 13.5kwh	5 sec	Today: Total energy generated today. Yesterday: Total energy generated yesterday.
Inverter SN 00000000000000	5 sec	Display serial number of the inverter.
Work Mode: Volt-watt DRM NO.:08	5 sec	Work Mode: Shows current working mode. DRM NO.: Shows DRM Number.
I_DC01: +05.0A I_DC02: +04.9A ... I_DC20: +05.2A	5 sec	I_DC01 : Shows input 01 current value. I_DC02 : Shows input 02 current value. ... I_DC20 : Shows input 20 current value.

Table 6.1 Information list

6.4.1 Lock Screen

Pressing the ESC key returns to the Main Menu. Pressing the ENTER key locks (Figure 6.2(a)) or unlocks (Figure 6.2 (b)) the screen.

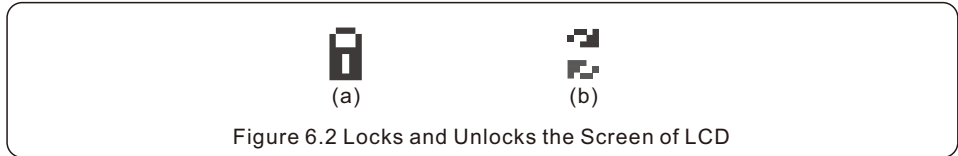

6.5 Settings

The following submenus are displayed when the Settings menu is selected:

1.Set Time

2.Set Address

6.5.1 Set Time

This function allows time and date setting. When this function is selected, the LCD will display a screen as shown in Figure 6.3.

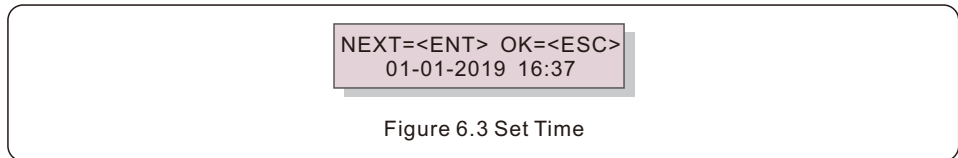

Press the UP/DOWN keys to set time and data. Press the ENTER key to move from one digit to the next (from left to right). Press the ESC key to save the settings and return to the previous menu.

6.5.2 Set Address

The address number can be assigned from "01" to "99" (see Figure 6.4). The default address number of Solis Three Phase Inverter is "01". When connecting multiple inverters with RS485 daisy chain, each inverter must have unique RS485 address from 01-99 .

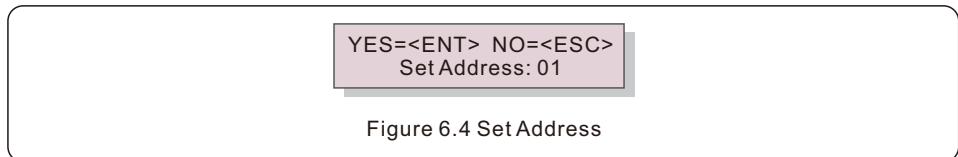

Press the UP/DOWN keys to set the address. Press the ENTER key to save the settings. Press the ESC key to cancel the change and return to the previous menu.

6.6 Advanced Info - Technicians Only



NOTE

To access to this area is for fully qualified and accredited technicians only. Enter menu "Advanced Info." and "Advanced settings" (need password) .

Select "Advanced Info." from the Main Menu. The screen will require the password as below:

```
YES=<ENT> NO=<ESC>
Password:0010
```

Figure 6.5 Enter password

The default password is "0010". Please press "down" to move the cursor, press "up" to select the number.

After enter the correct password the Main Menu will display a screen and be able to access to the following information.

- 1. Alarm Message
- 2. Running message
- 3. Version
- 4. Daily Energy
- 5. Monthly Energy
- 6. Yearly Energy
- 7. Daily Records
- 8. Communication Data
- 9. Warning Message

6.6.1 Alarm Message

The display shows the 100 latest alarm messages (see Figure 6.6). Screens can be scrolled manually by pressing the UP/ DOWN keys. Press the ESC key to return to the previous menu.

```
Alm000: OV-G-V
T: 00-00 00:00 D: 0000
```

Figure 6.6 Alarm Message

6.6.2 Running Message

This function is for the maintenance person to get running messages such as internal temperature, Standard No. 1,2,etc.

Screens can be scrolled manually by pressing the UP/DOWN keys.

6.6.3 Version

The screen shows the model version of the inverter. And the screen will show the software version by pressing the UP and DOWN at the same time. (see Figure 6.7).

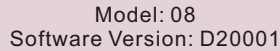

Model: 08
Software Version: D20001

Figure 6.7 Model Version and Software Version

6.6.4 Daily Energy

The function is for checking the energy generation for the selected day.

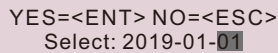

YES=<ENT> NO=<ESC>
Select: 2019-01-01

Figure 6.8 Select date for daily energy

Press DOWN key to move the cursor to day, month and year, press UP key to change the digit. Press Enter after the date is fixed.

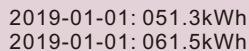

2019-01-01: 051.3kWh
2019-01-01: 061.5kWh

Figure 6.9 Daily energy

Press UP/DOWN key to move one date from another.

6.6.5 Monthly Energy

The function is for checking the energy generation for the selected month.

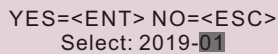

YES=<ENT> NO=<ESC>
Select: 2019-01

Figure 6.10 Select month for monthly energy

Press DOWN key to move the cursor to day and month, press UP key to change the digit. Press Enter after the date is fixed.

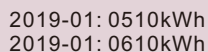

2019-01: 0510kWh
2019-01: 0610kWh

Figure 6.11 Monthly energy

Press UP/DOWN key to move one date from another.

6.6.6 Yearly Energy

The function is for checking the energy generation for the selected year.

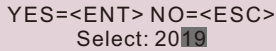

YES=<ENT> NO=<ESC>
Select: 2019

Figure 6.12 Select year for yearly energy

Press DOWN key to move the cursor to day and year, press UP key to change the digit. Press Enter after the date is fixed.

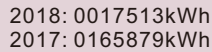

2018: 0017513kWh
2017: 0165879kWh

Figure 6.13 Yearly energy

Press UP/DOWN key to move one date from another.

6.6.7 Daily Records

The screen shows history of changing settings. Only for maintenance personnel.

6.6.8 Communication Data

The screen shows the internal data of the Inverter (see Figure 6.14), which is for service technicians only.

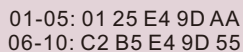

01-05: 01 25 E4 9D AA
06-10: C2 B5 E4 9D 55

Figure 6.14 Communication Data

6.6.9 Warning Message

The display shows the 100 latest warning messages (see Figure 6.15). Screens can be scrolled manually by pressing the UP/ DOWN keys. Press the ESC key to return to the previous menu.

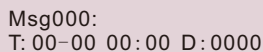

Msg000:
T: 00-00 00:00 D: 0000

Figure 6.15 Warning Message

6.7 Advanced Settings - Technicians Only



NOTE

To access to this area is for fully qualified and accredited technicians only. Please follow 6.4 to enter password to access this menu.

Select Advanced Settings from the Main Menu to access the following options:

- 1. **Select Standard**
- 2. **Grid ON/OFF**
- 3. **Clear Energy**
- 4. **Reset Password**
- 5. **Power Control**
- 6. **Calibrate Energy**
- 7. **Special Settings**
- 8. **STD. Mode Settings**
- 9. **Restore Settings**
- 10. **HMI Update**
- 11. **External EPM set**
- 12. **Restart HMI**
- 13. **Debug Parameter**
- 14. **DSP Update**
- 15. **Compensation Set**
- 16. **I/V Curve**

6.7.1 Selecting Standard

This function is used to select the grid reference standard (see Figure 6.16).

```
YES=<ENT> NO=<ESC>  
Standard:IEEE1547-18
```

Figure 6.16

6.7.2 Grid ON/OFF

This function is used to start up or stop the power generation of Solis Three Phase Inverter (see Figure 6.18).



Figure 6.18 Set Grid ON/OFF

Screens can be scrolled manually by pressing the UP/DOWN keys. Press the ENTER key to save the setting. Press the ESC key to return to the previous menu.

6.7.3 Clear Energy

Clear Energy can reset the history yield of inverter



NOTE

These two functions are applicable by maintenance personnel only, wrong operation will prevent the inverter from working properly.

6.7.4 Reset Password

This function is used to set the new password for menu “Advanced info.” and “Advanced information” (see Figure 6.19).

A screenshot of a menu with a light purple background. It contains two lines of text: 'YES=<ENT> NO=<ESC>' and 'Password: 0000'.

Figure 6.19 Set new password

Enter the right password before set new password. Press the DOWN key to move the cursor, Press the UP key to revise the value. Press the ENTER key to execute the setting. Press the ESC key to return to the previous menu.

6.7.5 Power Control

Active and reactive power can be set through the power setting button.

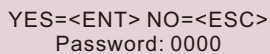
There are 5 item for this sub menu:

1. **Set output power**
2. **Set Reactive Power**
3. **Out_P With Restore**
4. **Rea_P With Restore**
5. **Select PF Curve**
6. **Max Power Choose** (With this setting, you can adjust the Max AC output power up to 1.1 times of Rated AC output power)



NOTE

This function is applicable by maintenance personnel only, wrong operation will prevent the inverter from reaching maximum power.

6.7.6 Calibrate Energy

Maintenance or replacement could clear or cause a different value of total energy. Using this function could allow user to revise the value of total energy to the same value as before. If the monitoring website is used the data will be synchronous with this setting automatically. (see Figure 6.20).

```
YES=<ENT> NO=<ESC>
Energy:0000000kWh
```

Figure 6.20 Calibrate energy

Press the DOWN key to move the cursor, Press the UP key to revise the value. Press the ENTER key to execute the setting. Press the ESC key to return to the previous menu.

6.7.7 Special Settings



NOTE

This function is applicable by maintenance personnel only, wrong operation will prevent the inverter from reaching maximum power.

6.7.8 STD Mode Settings IEEE1547-18



NOTE

This section is applicable to maintenance personnel only.

Selecting "STD Mode Settings" displays the sub-menu shown below:

1. Working Mode Set
2. Power Rate Limit
3. Freq Derate Set
4. 10mins Voltage Set
5. Power Priority
6. Initial Settings
7. Voltage PCC Set
8. Freq-Watt

6.7.8.1 Working Mode Set

There are TWO situations with different grid standards selected.

6.7.8.1.1 With IEEE1547-18 Standard selected



NOTE

The following modes are for "IEEE1547-18".

Solis US version inverters have Seven working modes:

1. NULL
2. Volt-watt
3. Volt-Var
4. Fixed-PF
5. Reac-power
6. Power-PF
7. VgWatt-UL

Based on UL1741SB, working mode 1,3,4,7 can be used by grid operator.

1. NULL

Description: Inverter is not under any working mode.

2. Volt-Watt (Not Required)

Description: Inverter will change the active output power based on voltage change.

Note: This Setting is NOT required by UL1741SB Standards.



NOTE

This function is for maintenance personnel only, wrong operation will prevent the inverter from reaching maximum power.

3. Volt-Var (Default)

Description: Inverter will change the reactive output power based on voltage change.

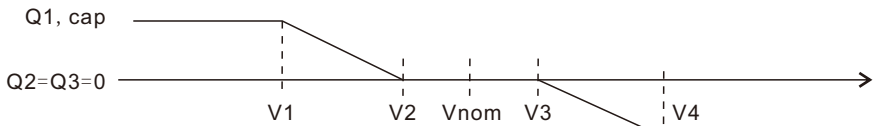

Figure 6.21 Volt-VAR curve for Q (V)

Default Settings for UL1741SB:

Q1: (0-60%) Default +44% Q4: (-60%-0%) Default -44%

Rated 480V Grid

V1:(369.6-494.4V) Default 441.6V V2: (441.6-504V) Default 470.4V

V3:(456-518.4V) Default 489.6V V4: (465.6-590.4V) Default 518.4V

Voltage1 : 441.6V
Voltage2 : 470.4V

Figure 6.22 Volt-VAR

4.Fixed-PF

Description: Inverter will output power with fixed power factor.

Setting Range: -0.8 to +0.8

Default value is PF = 1

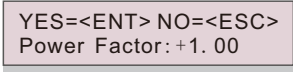

YES=<ENT> NO=<ESC>
Power Factor: +1.00

Figure 6.23 Fixed-PF

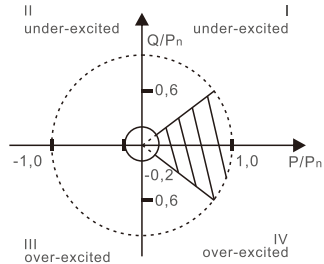

Figure 6.24 PF Range

5. Reac-power (Not Required)

Description: Inverter will generate reactive power based on changing output power.

Note: This Setting is NOT required by UL1741SB Standards.



NOTE

This function is for maintenance personnel only, wrong operation will prevent the inverter from reaching maximum power.

6. P-factor (Not Required)

Description: Inverter will change power factor based on changing output power.

Note: This Setting is NOT required by UL1741SB Standard.



NOTE

This function is for maintenance personnel only, wrong operation will prevent the inverter from reaching maximum power.

7.VgWatt-UL

Description: Inverter will change the active output power based on voltage change.

Note: This is the Volt-Watt Setting for UL1741SB Standard.

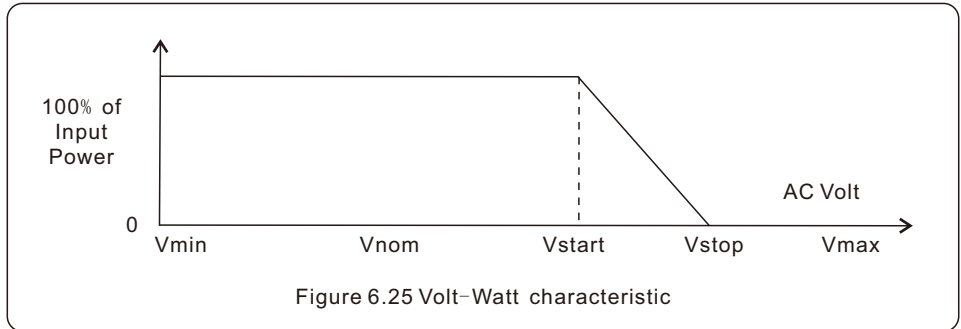

Default Settings for UL1741SB:

Rated 480V Grid

V1: less than V2

V2: less than Vstart

V3 (Vstart): (504-523.2V) Default 508.8V

V4 (Vstop): (508.8-528V) Default 528V

P1:100% P2:100% P3: 100% P4:20%

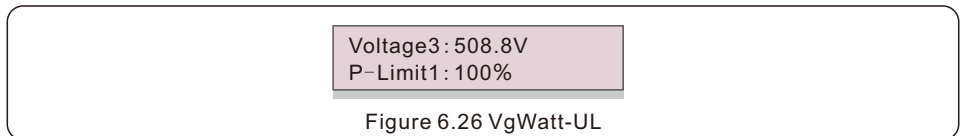

6.7.8.1.2 With Rule21 Standard selected



NOTE

The following modes are for "R21P3".

Solis US version inverters have ten working modes:

- | | |
|----------------------|--|
| 1. NULL | 6. Power -PF |
| 2. Volt-watt | 7. VgWatt-UL |
| 3. Volt-Var | 8. Volt-Var and Volt Watt enabled |
| 4. Fixed-PF | 9. Ramp Rate |
| 5. Reac-power | 10. Frequency Derate |

Based on Rule21, working mode 1,2,3,4 can be used by grid operator.



NOTE

The other three working mode "P1-V-Watt", "P1-V-Var" and "P1-V-P&V-Q" are NOT applicable for settings.

1.NULL (Mode Reset)

Description: Inverter is not under any working mode.

2. Volt-Watt

Description: Inverter will change the active output power based on voltage change.

Note: This is the Volt-Watt Setting for Rule21 Standards.

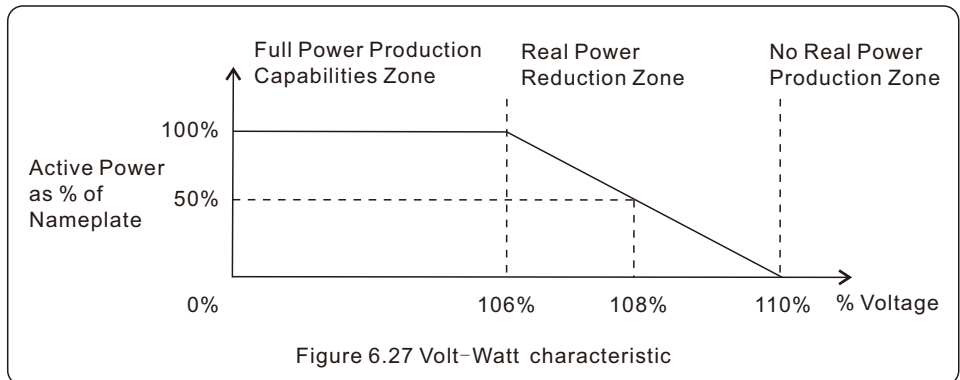

Default Settings for Rule21 Standards:

Rated 480V Grid

V1: less than Vstart

V2: less than Vstart

V3 (Vstart): (480-576V) Default 508.8V

V4: (Vstop): (480-576V) Default 528V

P1:100% P2:100% P3: 100% P4:0%

3. Volt-Var

Description: Inverter will change the reactive output power based on voltage change.

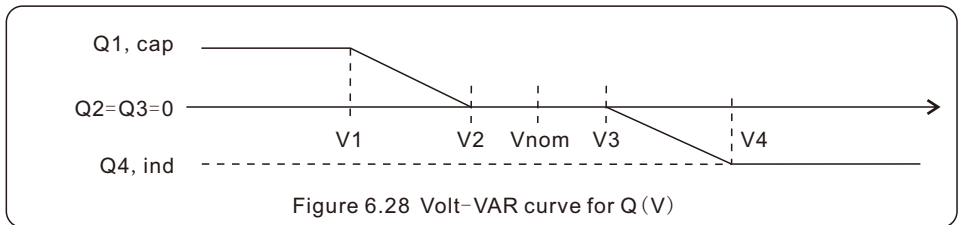

Default Settings for Rule21 Standard:

Q1: (0-60%) Default +30% Q4: (-60%-0%) Default -30%

Rated 480V Grid

V1:(384-480V) Default 441.6V V2: (384-528V) Default 464.2V

V3:(480-576V) Default 495.9V V4: (480-576V) Default 513.6V

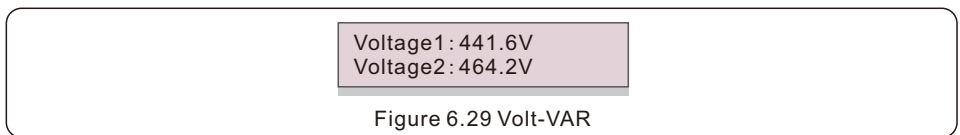

4.Fixed-PF

Description: Inverter will output power with fixed power factor.

Setting Range: -0.8 to +0.8

Default value is PF = 1

YES=<ENT> NO=<ESC>
Power Factor: +1.00

Figure 6.30 Fixed-PF

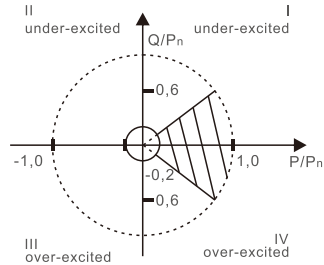

Figure 6.31 PF Range

5. Reac-power (Not Required)

Description: Inverter will generate reactive power based on changing output power.

Note: This Setting is NOT required by Rule21 Standards.



NOTE

This function is for maintenance personnel only, wrong operation will prevent the inverter from reaching maximum power.

6. P-factor (Not Required)

Description: Inverter will change power factor based on changing output power.

Note: This Setting is NOT required by Rule21 Standards.



NOTE

This function is for maintenance personnel only, wrong operation will prevent the inverter from reaching maximum power.

7. VgWatt-UL (Not Required)

Description: Inverter will change the active output power based on voltage change.

Note: This Setting is NOT required by Rule21 Standards.



NOTE

This function is for maintenance personnel only, wrong operation will prevent the inverter from reaching maximum power.

8. Enable both Volt-Var and Volt-Watt modes

Description: Rule21 requires both Volt-var and Volt-watt modes to be enabled.

To set both modes (Volt-var in high priority)

Step 1: Select and set Volt-watt mode at first.

Step 2: Enter "Working Mode" again and select and set Volt-var mode then.

Step 3: To check the priority, a new mode will appear as "V-Q & V-P" which indicates (Q) Volt-var is in high priority.

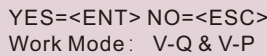

YES=<ENT> NO=<ESC>
Work Mode: V-Q & V-P

Figure 6.32 Work Mode

To set both modes (Volt-watt is in high priority)

Step 1: Select and set Volt-var mode at first.

Step 2: Enter "Working Mode" again and select and set Volt-watt mode then.

Step 3: To check the priority, a new mode will appear as "V-P & V-Q" which indicates (P) Volt-watt is in high priority.

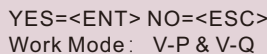

YES=<ENT> NO=<ESC>
Work Mode: V-P & V-Q

Figure 6.33 Work Mode

To reset dual-mode or exit the dual-mode situation

Step 1: Select "Null" mode at first.

Step 2: Enter "Working Mode" again. Redo above dual-mode setting steps to reset OR set other modes to exit dual-mode situation.



NOTE

To check the Volt-watt and Volt-var priority, simply enter the working modes. V-Q&V-P indicates Volt-Var First V-P&V-Q indicates Volt-Watt First

6.7.8.2 Power Rate Limit

This function is used for change Power Ramp-up rate. When inverter start up or input string MPPT changes, inverter power ramp-up rate is limited in this menu.

The default setting is stop (disable).

The setting range from 1% to 100%, means inverter power change rate per minute.

Values are not allowed to change. If they are changed, they may not conform to the UL1741SA standard.

Power Rate:016%
RateP_Sts-US:STOP

Figure 6.34 Power Rate Limit

6.7.8.3 Freq Derate Set

This setting is applicable when UL Standards are selected.

There are 5 derate modes in this menu. When operating under UL 1741 limits, modes 00 to 03 are disabled. Mode 04 is used for UL 1741SA frequency derate setting. This sets the 'f' stop point.

The default setting is 00, means this function is disabled.

Derate Mode: 04
OV-F-Start: 60. 20Hz

Figure 6.35 Freq Derate Set

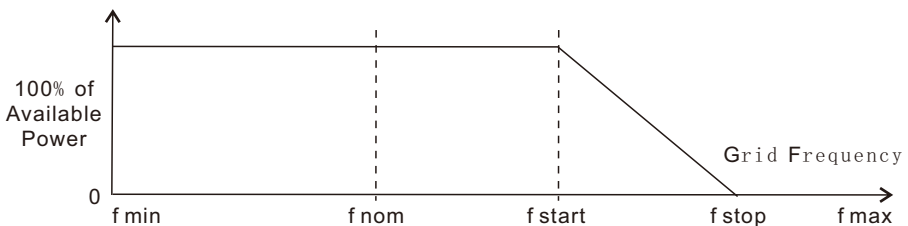

Figure 6.36 Freq-Watt characteristic

Over frequency load shedding Fstart range 60~62Hz, default setting 60.2Hz

Fstop can set the scope: 61-64Hz, the default setting 62Hz.

Press the Enter key to select the mode or frequency.

Press Up/Down to set. Press ESC to save the settings.

6.7.8.4 10mins Voltage Set

This function is disabled and not used for the US.



NOTE

This function is for maintenance personnel only, wrong operation will prevent the inverter from reaching maximum power.

6.7.8.5 Power Priority

This setting is used to set the priority between Active Power Control (Watt) and Reactive Power Control (Var).

YES=<ENT> NO=<ESC>
Select: Var First

Figure 6.37 Power Priority

Two options are available: Watt First and Var First.



NOTE

This function is for maintenance personnel only, wrong operation will prevent the inverter from reaching maximum power.

6.7.8.6 Initial Settings

In initial settings it will reset each work mode from 6.5.8.1 to 6.5.8.4 back to default.

Work Mode Default
Power Rate Default

Figure 6.38 Initial Settings

6.7.8.7 Voltage PCC Set

Set the voltage at the PCC point.

This setting is required by RULE 21 requirements.

PCC: Point of Common Coupling, the point where a Local EPS is connected to an Area EPS.



NOTE

This function is for maintenance personnel only, wrong operation will prevent the inverter from reaching maximum power.

6.7.8.8 Freq-Watt

This setting is used to control real power based on the frequency excursion.
This setting is applicable when Rule21 Standards are selected.

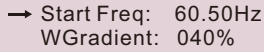

→ Start Freq: 60.50Hz
WGradient: 040%

Figure 6.39 Freq-Watt (1)

Start Freq: This is the frequency that active power reduction starts.
WGradient: This is the active power reduction rate in terms of the frequency.
Stop Freq: This is the frequency that stops the correction cycle.
Hysteresis: This indicates whether hysteresis is enabled.

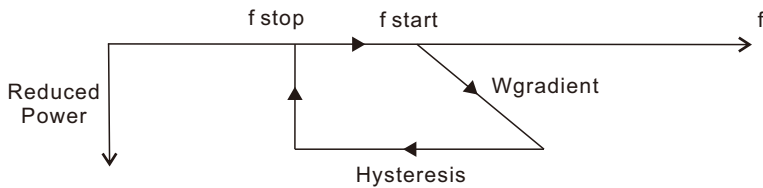

Figure 6.40 Freq-Watt (2)



NOTE

This function is for maintenance personnel only, wrong operation will prevent the inverter from reaching maximum power.

6.7.9 Restore Settings



NOTE

This section is applicable to maintenance personnel only.

Selecting “Restore Settings” displays the option shown below:

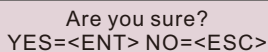

Are you sure?
YES=<ENT> NO=<ESC>

Figure 6.41

Press the ENTER key to reset to factory defaults.
Press the ESC key to return to the previous menu.

6.7.10 HMI Updater



NOTE

This section is applicable to maintenance personnel only.

Selecting “Updater” displays the sub-menu shown below:

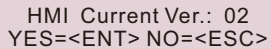

HMI Current Ver.: 02
YES=<ENT> NO=<ESC>

Figure 6.42

Updater is for updating LCD firmware. Press the ENTER key to start the process.
Press the ESC key to return to the previous menu.

6.7.11 External EPM Set

This function is turned on when the EPM is external.



YES=<ENT> NO=<ESC>
Fail Safe Set:ON

Figure 6.43 Set the Fail Safe ON/OFF

6.7.12 Restart HMI

The function is used for restarting the HMI.



NOTE

This function is applicable by maintenance personnel only, wrong operation will prevent the inverter from reaching maximum power.

6.7.13 Debug Parameter



NOTE

This section is applicable to maintenance personnel only.

Debug Parameter as shown as below:

```
→ S16DAT1: +0000
S16DAT2: +0000
S16DAT3: +0000
S16DAT4: +0000
S16DAT5: +0000
S16DAT6: +0000
S16DAT7: +0000
S16DAT8: +0000
```

Figure 6.44

Press the UP/DOWN keys to scroll through items. Press the ENTER key to select.

Press the DOWN key to scroll and press the UP key to change the value.

Press the ENTER key to save the setting. Press the ESC key to cancel.

changes and return to the previous menu.

6.7.14 FAN Test



NOTE

This section is applicable to maintenance personnel only.

Selecting “Fan Test” displays the sub-menu shown below:

```
Are you sure?
YES=<ENT> NO=<ESC>
```

Figure 6.45

Fan Test is a factory test function. Press the ENTER key to start the test.

Press the ESC key to return to the previous menu. (Refer to section 7.2 for fan maintenance and replacement).

6.7.15 DSP Update

The function is used for updating the DSP.



NOTE

This function is applicable by maintenance personnel only, wrong operation will prevent the inverter from reaching maximum power.

6.7.16 Compensation Set

This function is used to calibrate inverter output energy and voltage. It will not impact the energy count for inverter with RGM.

Two sections are included: Power Parameter and Voltage Parameter.

The screen shows:

```
YES=<ENT> NO=<ESC>  
Power para: 1.000
```

Figure 6.46 Power Rate Limit

Press the Down key to move the cursor.

Press the Up key to change the digit.

Please press the Enter to save the setting and press the ESC key to return to the previous menu.



NOTE

This setting is used for grid operators, do not change this setting unless specifically instructed to.

6.7.17 I/V Curve

This function is used to scan the I/V characteristic curves of each PV strings.

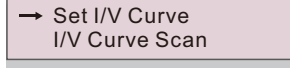

Figure 6.47 I/V Curve

6.7.17.1 Set I/V Curve

This setting can set the scanning voltage start point and the voltage interval.

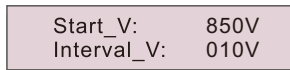

Figure 6.48 Set I/V Curve

Start_V: The start voltage of the I/V scan. (Adjustable from 300V-1000V)

Interval_V: The scanning voltage interval. (Adjustable from 1-100V)

In total, 60 data points can be scanned.

6.7.17.2 I/V Curve Scan

Press "ENT" to start the I/V curve scan.

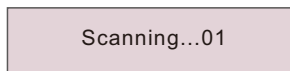

Figure 6.49 I/V Curve Scan (1)

After it is completed, the screen will display "Scan OK" and then enter the following section.

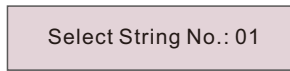

Figure 6.50 I/V Curve Scan (2)

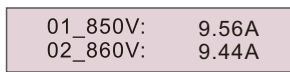

Figure 6.51 I/V Curve Scan (3)

6.8 AFCI function

Solis inverters have the built-in AFCI function which can detect the arc fault on the DC circuit and shut down the inverter to prevent a fire disaster.

6.8.1 Enable the AFCI function

The AFCI function can be enabled in the following method.

Path: Advanced Setting -> Password: 0010 -> Special Settings -> AFCI Set -> AFCI ON/OFF -> ON

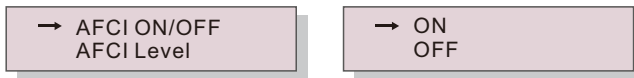

Figure 6.52 Set AFCI



WARNING

The "AFCI Level" is reserved for Solis technicians ONLY. Do not change the sensitivity otherwise it will lead to frequent false alarms or malfunctions. Solis is not responsible for any further damages caused by unauthorized modifications.



NOTE

The setting corresponds to the current status as well which can be used to inspect the ON/OFF state of the AFCI function.

6.8.2 Arc Fault

During the normal operation, if a DC arc is detected, the inverter will shut down and give out the following alarm:

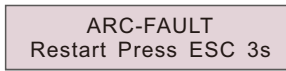

Figure 6.53 Arc Fault

The installer needs to thoroughly inspect the DC circuit to ensure all the cables are correctly fastened.

Once the DC circuit issue has been fixed or it is confirmed to be OK, press "ESC" for 3s and wait for the inverter to restart.

Solis Three Phase Inverter does not require any regular maintenance. However, cleaning the dust on heat-sink will help the inverter to dissipate the heat and increase its life time. The dust can be removed with a soft brush.



CAUTION

Do not touch the inverter's surface when it is operating. Some parts of the inverter may be hot and cause burns. Turn off the inverter (refer to Section 6.2) and wait for a cool-down period before any maintenance or cleaning operation.

The LCD and the LED status indicator lights can be cleaned with a damp cloth if they are too dirty to be read.



NOTE

Never use any solvents, abrasives or corrosive materials to clean the inverter.

7.1 Anti-PID Function

Solis inverter integrates optional Anti-PID module and it can recover the PID effect during night thus protect the PV system from degradation.

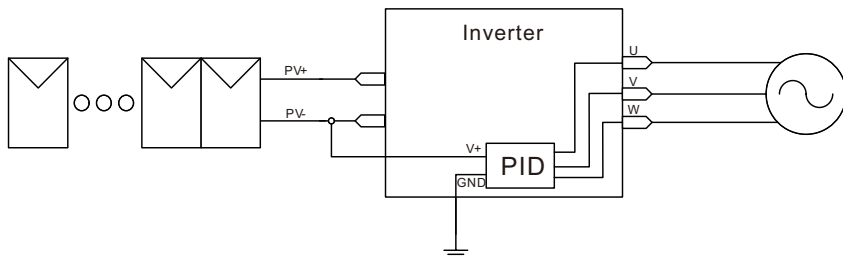

Figure 7.1

The Anti-PID module repairs the PID effect of the PV module at night. When operating, the inverter LCD screen displays "PID-repairing" information, and the red light is on. The Anti-PID function is always ON when AC is applied. If maintenance is required turning off the AC switch will disable the Anti-PID function.



WARNING

The PID function is automatic. When the DC bus voltage is lower than 50Vdc, the PID module will start creating 450 Vdc between PV(-) and ground. No need for any control or settings



NOTE

If you need to maintain the inverter at night, please turn off the AC switch first, then turn off the DC switch, and wait 5 minutes before you do other operations.

7.2 Fan Maintenance

If the fan does not work properly, the inverter will not be cooled effectively and it will affect the inverter operation. A warning message Fan Fail will be displayed on the LCD. It is necessary to clean or replace a broken fan as follows:

1. Turn off the “Grid ON/OFF” switch on the inverter LCD (Section 6.2).
2. Disconnect the AC power
3. Turn the DC switch to “OFF” position
4. Wait at least 15 minutes.
5. Remove the 4 screws on the fan plate and slowly pull out the fan assembly.



Figure 7.2

6. Disconnect the fan connector carefully and take out the fan.

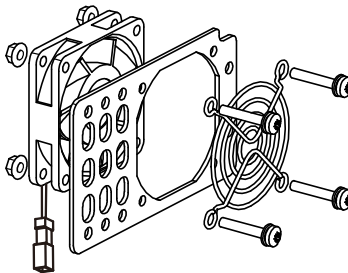

Figure 7.3

7. Clean or replace the fan. Assemble the fan on the rack.
8. Connect the electrical wire and reinstall the fan assembly. Restart the inverter.

8.1 Current Alarm

8.1.1 Running messages

Running messages can be viewed on the screen including any current alarms.

8.2 Alarm History

8.2.1 Viewing alarm history

Refer to LCD Operation 6.6.8 for instructions on viewing Alarm History.

8.3 Error Messages



NOTE

The first step to clearing alarms as listed in Table 9, is to reset the inverter. To reset the inverter, turn off the inverter (refer to Section 6.2) and wait for five (5) minutes before restarting it (refer to Section 6.1). If the failure persists, please first contact your local distributor and then Solis Support Service.

If you need to contact Solis Support Service, please call +1(866) 438-8408 or emails us to usservice@solisinverters.com

Please have the following information available when contacting technical support:

1. Inverter serial number
2. The inverter distributor/dealer (if available)
3. Installation date
4. The description of problem (e.g., the alarm message displayed on the screen and the status of the screen status indicator lights. Other readings obtained from the Information sub menu (refer to Section 6.4) will also be helpful.)
5. PV array configuration (e.g. number of panels, panel capacity, number of strings, etc.)
6. Your contact details

8.3.1 Troubleshooting guide

Solis inverters are designed in accordance with international grid standards, safety standards and electromagnetic compatibility requirements. Before delivery to the customer, the inverter has been subjected to intensive testing to ensure its optimal operation and reliability.

In case of failure, the screen may display an alarm message, stop feeding energy into the grid or both. Typical failure descriptions and their corresponding alarm messages are listed in Table 8.1 on the following pages.

Alarms	Cause	Solution
No Information (Blank Screen)	<ul style="list-style-type: none"> • Input voltage low/missing • Polarity reversed • Main board damaged 	<p>Test – DC switch OFF</p> <ul style="list-style-type: none"> • Check PV connections • Check polarity • Check voltage >200V <p>Test – DC Switch ON</p> <ul style="list-style-type: none"> • Check voltage >200V • If DC voltage is “0” replace inverter
Initializing (Inverter stuck in this mode)	<ul style="list-style-type: none"> • Inverter is waiting for driving signal 	<p>Test – DC switch OFF</p> <ul style="list-style-type: none"> • Check PV connections • Check polarity • Check voltage >200V <p>Test – DC Switch ON</p> <ul style="list-style-type: none"> • Check voltage >200V • A cable may have been damaged or loosened in shipping replace inverter
OV-G-V: Over Grid Voltage	<ul style="list-style-type: none"> • Inverter detects grid voltage as too high 	<p>Test – DC switch OFF</p> <ul style="list-style-type: none"> • Check AC at the inverter • If AC measures high, adjust upper limit with permission from utility <p>Test – DC Switch ON, full power</p> <ul style="list-style-type: none"> • Check AC at inverter test points • Compare with LCD • If AC measures high, cables between inverter and interconnect are too small • Check ampacity and voltage drop calculations
UN-G-V: Under Grid Voltage	<ul style="list-style-type: none"> • Inverter detects grid voltage as too low 	<p>Test – DC switch OFF</p> <ul style="list-style-type: none"> • Check AC at the inverter test points • If AC measures low, adjust lower limit with permission from utility • Check LCD voltage reading, may be a bad measurement circuit <p>Test – DC Switch ON</p> <ul style="list-style-type: none"> • Check grid standard • Replace inverter
UN-BUS: DC BUS voltage is too low	<ul style="list-style-type: none"> • Inverter detects low DCV on internal bus 	<p>Test</p> <ul style="list-style-type: none"> • Measure DC and AC voltages • Compare with LCD • Replace Inverter • Internal damage • Wire came loose during shipping

Alarms	Cause	Solution
<p>OV-G-F: Over Grid Frequency</p>	<ul style="list-style-type: none"> • Inverter detects grid Frequency as too high 	<p>Test – DC switch OFF</p> <ul style="list-style-type: none"> • Check frequency at the inverter test points • If Frequency measures high, adjust upper limit with permission from utility • Check LCD reading, may be a bad measurement circuit <p>Test – DC Switch ON</p> <ul style="list-style-type: none"> • Check grid standard • Replace inverter
<p>NO-GRID</p>	<ul style="list-style-type: none"> • Inverter does not detect the grid 	<p>Test – DC switch OFF</p> <ul style="list-style-type: none"> • Check AC at the inverter test points • L-L, L-GND • Check LCD reading, may be a bad measurement circuit <p>Test – DC Switch ON</p> <ul style="list-style-type: none"> • Check grid standard • Replace inverter
<p>OV-DC: DC voltage is too high</p>	<ul style="list-style-type: none"> • Inverter detects High DC Voltage 	<p>Test – DC switch OFF</p> <ul style="list-style-type: none"> • Check DC at the inverter test points • If DC Voltage is high, check string configuration <p>Test – DC Switch ON</p> <ul style="list-style-type: none"> • Check LCD reading, may be a bad measurement circuit • Replace inverter
<p>OV-BUS: DC BUS voltage is too high</p>	<ul style="list-style-type: none"> • Inverter detects High DC Voltage on internal bus 	<p>Test</p> <ul style="list-style-type: none"> • Measure DC and AC voltages • Compare with LCD • Replace Inverter • Internal damage • Wire came loose during shipping
<p>GRID-INTF: Grid unstable</p>	<ul style="list-style-type: none"> • Inverter detects grid instability, internal fault current high 	<p>Test – With DC Switch OFF</p> <ul style="list-style-type: none"> • Measure AC voltage • Test AC line for THD • Test – With DC Switch ON <p>Test AC line for THD</p> <ul style="list-style-type: none"> • Multiple inverters/turn one off • Impedance matching adjustment or box • Internal damage • Wire came loose in shipping

Alarms	Cause	Solution
INI-FAULT: Initialization Protection	<ul style="list-style-type: none"> • Master and Slave DSP have different values 	Reset Inverter <ul style="list-style-type: none"> • DC switch OFF. • Wait until all lights/LCD turn off. • DC switch ON. • Replace inverter.
OV-TEM: Temperature Protection	<ul style="list-style-type: none"> • Inverter detects high ambient temperature >60C 	Inspect installation <ul style="list-style-type: none"> • Check heatsink for obstructions/ventilation. • Is inverter in direct sunshine. • Measure ambient temperature near inverter. • If temp is in range replace inverter.
PV ISO-PRO 01/02: Ground Protection	<ul style="list-style-type: none"> • Inverter detects low DC insulation resistance 	Inspect installation <ul style="list-style-type: none"> • Reset inverter. • Note weather conditions when alarm occurs. • Measure insulation resistance. • If normal, measure in SAME weather as alarm. • Physically check cables. • Change Riso limit from 500k to 50k. • Replace inverter.
ARC-FAULT	<ul style="list-style-type: none"> • Inverter detects arc in DC circuit 	Inspect installation <ul style="list-style-type: none"> • Check cable with string tester. • Physically check cables. • Inspect panel junction boxes. • Inspect cable connections. • Reset inverter. • Replace inverter.
Screen OFF with DC applied	<ul style="list-style-type: none"> • Inverter internally damaged 	<ul style="list-style-type: none"> • Do not turn off the DC switches as it may damage the inverter. • Please wait for sunset and confirm the string current is less than 0.5A with a clip-on ampmeter and then turn off the DC switch. String current above 0.5A is under load. • Note: Damage due to wrong connections or fire caused by removing string wires or opening fuse holders under load is not covered in the device warranty.
Reve-DC	<ul style="list-style-type: none"> • One of the DC string is reversely connected • OR different number of modules are connected to the string inputs (Threshold varies between different conditions) 	<ul style="list-style-type: none"> • Please check the inverters' PV string polarity, if there are strings reversely connected wait for the night when the solar irradiance is low and the PV string current down below 0.5A. Turn off the two DC switches and fix the polarity issue. • If string polarity is correct, please confirm that all the PV strings have the same number of modules. If not, please modify the system configuration.

Table 8.1 Fault messages and descriptions

Alarms	Cause	Solution
UN-BUS: DC Bus Undervoltage	<ul style="list-style-type: none"> • DC BUS Voltage too low for inverter to operate 	<p>Inspect installation</p> <ul style="list-style-type: none"> • Check PV DC Input Voltage. • Restart The inverter. • Replace inverter.
DC-INTF: DC input disturbance	<ul style="list-style-type: none"> • Inverter detect abnormal DC current 	<p>Inspect installation</p> <ul style="list-style-type: none"> • Check if there is any damage to DC wiring. • Restart the inverter. • Replace inverter.
G-PHASE: Unbalanced Grid	<ul style="list-style-type: none"> • 3 phase Grid unbalance 	<p>Inspect installation</p> <ul style="list-style-type: none"> • Restart the inverter. • Measure grid current on each phase. Make sure the current is balance. • Check inverter properly connected to the grid.
G-F-FLU: Grid frequency fluctuation	<ul style="list-style-type: none"> • Abnormal frequency on grid site 	<p>Inspect installation</p> <ul style="list-style-type: none"> • Restart the inverter. • Monitor Grid frequency variations.
UN-G-F: Grid under frequency	<ul style="list-style-type: none"> • Grid frequency is lower than inverter frequency range 	<p>Inspect installation</p> <ul style="list-style-type: none"> • Restart the inverter. • Check inverter under frequency settings. • Make sure the settings are within the operating range of the inverter.
OV-G-I: Grid overcurrent	<ul style="list-style-type: none"> • The output current of the inverter is too high 	<p>Inspect installation</p> <ul style="list-style-type: none"> • Restart the inverter. • Confirm the grid connection is correct. • Measure output current of the inverter. Make sure it is within inverter specification. • Replace inverter.
PID Repairing: Inverter logic fault	<ul style="list-style-type: none"> • DSP FW fault • RSD fault 	<p>Inspect installation</p> <ul style="list-style-type: none"> • Check RSD transmitter and Power Supply. • Check DC voltages at inverter terminals. • Check Inverter DSP FW version by holding the "Enter" key for 10 seconds. If DSP version reads 00 contact Solis service or replace the inverter.
IGFOL-F: Grid current tracking is abnormal	<ul style="list-style-type: none"> • Grid current tracking failure 	<p>Inspect installation</p> <ul style="list-style-type: none"> • Restart the inverter. • Replace inverter.

Table 8.1 Fault messages and descriptions

Alarms	Cause	Solution
ILeak-PRO: Leakage current protection	<ul style="list-style-type: none"> • Grid side current leakage protection 	Inspect installation <ul style="list-style-type: none"> • Check PV string wire insulation and connect one string at the time to the DC input. • Check AC wire insulation for any damage. • If the error occurs only on a rainy and high humidity day, the problem is due to poor wire insulation on the PV or Grid connection. • Change protection settings to 300mA.
RelayChk-Fail: Relay detection failure	<ul style="list-style-type: none"> • Relay fault protection 	Inspect installation <ul style="list-style-type: none"> • Restart the inverter. • Replace Inverter.
DSP-B-Fault: DSP-B internal protection	<ul style="list-style-type: none"> • General fault between master DSP and slave DSP 	Inspect installation <ul style="list-style-type: none"> • Restart the inverter. • Replace Inverter.
DCInj-Fault: Excessive DC component	<ul style="list-style-type: none"> • Excessive DC components on the Grid current 	Inspect installation <ul style="list-style-type: none"> • Restart the inverter. • Replace Inverter.
ILeak-Check: Leakage current self check protection	<ul style="list-style-type: none"> • Leakage current sensor self check fault 	Inspect installation <ul style="list-style-type: none"> • Restart the inverter. • Replace inverter.
AFCI-Check: AFCI self check protection	<ul style="list-style-type: none"> • AFCI components self protection failure 	Inspect installation <ul style="list-style-type: none"> • Restart the inverter. • Replace inverter.
IGBT-OV-I: IGBT overcurrent	<ul style="list-style-type: none"> • IGBT overcurrent 	Inspect installation <ul style="list-style-type: none"> • Restart the inverter. • Replace inverter.
UN-TEM: Under temperature protection	<ul style="list-style-type: none"> • Temperature is too low 	Inspect installation <ul style="list-style-type: none"> • Check ambient temperature. Make sure it is above -30°C • Restart the inverter. • Replace inverter.

Table 8.1 Fault messages and descriptions

Alarms	Cause	Solution
IG-AD: Abnormal grid current sampling	<ul style="list-style-type: none"> • Grid current sampling by the inverter is abnormal 	Inspect installation <ul style="list-style-type: none"> • Restart the inverter. • Replace Inverter.
DSP-SelfCheck: DSP self-check is abnormal	<ul style="list-style-type: none"> • DSP Failed to enable self-detection 	Inspect installation <ul style="list-style-type: none"> • Restart the inverter. • Replace Inverter.
BoostFal: DC Boost converter fault	<ul style="list-style-type: none"> • DC Boost converter circuit fault 	Inspect installation <ul style="list-style-type: none"> • Restart the inverter. • Replace Inverter.
OV-DCA-I: DC1 average overcurrent	<ul style="list-style-type: none"> • The lightning protection on the left board is abnormal 	Inspect installation <ul style="list-style-type: none"> • Restart the inverter. • Replace Inverter.
OV-DCB-I: DC1 average overcurrent	<ul style="list-style-type: none"> • The lightning protection on the right board is abnormal 	Inspect installation <ul style="list-style-type: none"> • Restart the inverter. • Replace Inverter.
OV-IgTr: Grid current transient overcurrent	<ul style="list-style-type: none"> • The instantaneous current on the power grid exceeds the overcurrent threshold 	Inspect installation <ul style="list-style-type: none"> • Restart the inverter. • Confirm the grid connection is correct. • Measure output current of the inverter. Make sure it is within inverter specification. • Replace inverter.
DRM LINK Fail: DRM link failed	<ul style="list-style-type: none"> • DRM link is abnormal 	Inspect installation <ul style="list-style-type: none"> • Restart the inverter. • Check DRM link cables. • Check if DRM link signal is N.C (normally closed) • Check if DRM cables inside the inverter is connected properly.
PHASE FAULT: Abnormal phase of the grid	<ul style="list-style-type: none"> • Abnormal phase of the grid 	Inspect installation <ul style="list-style-type: none"> • Check grid wiring connected properly. • Check if phase angle of the grid is 120° between phases. • Restart the inverter. • Replace inverter.

Table 8.1 Fault messages and descriptions

9. Specifications

Model	S6-GC25K-US
Max. DC input voltage (Volts)	1000
Rated DC voltage (Volts)	720
Start-up voltage (Volts)	180
MPPT voltage range (Volts)	160...1000
Full load MPPT voltage range (Volts)	580...850
Max. input current (Amps)	3x40
Max short circuit input current (Amps)	3x63
MPPT number/Max input strings number	3/6
Rated output power (Watts)	25000
Max. output power (Watts)	25000
Max. apparent output power (VA)	25000
Rated grid voltage (Volts)	3/PE~480
Max. output current (Amps)	30.1
Power Factor (at rated output power)	> 0.99 (0.8 leading - 0.8 lagging)
THDi (at rated output power)	<3%(at rated output power)
Rated grid frequency (Hertz)	60
Max. efficiency	98.8%
CEC efficiency	98.3%
Surge Protection	DC Type II / AC Type II
Integrated AFCI (DC arc-fault circuit protection)	YES
Integrated PID recovery	YES
Dimensions (W*H*D)	784*549*320 (mm) / 30.9x21.6x12.6 (inch)
Weight	43.7kg / 96.3lb
Topology	Transformerless
Self consumption (night)	< 1W
Operating ambient temperature range	-13...140°F / -25...+60°C
Storage environment	-40...176°F / -40...+80°C
Relative humidity	0~100%
Ingress protection	Type 4X
Noise emission	≤55dB(A)
Cooling concept	Intelligent redundant cooling
Max.operation altitude	13120ft / 4000m
Compliance	UL1741, UL1741SA, UL1741SB, Rule 21, UL1998 IEEE 1547, FCC Part 15 (Class A & B), UL1699B CAN/CSA C22.2 107.1-1, Rule 21 Phase II&III
DC connection	MC4 connectors
AC connection	OT Terminal connectors (Max . 250MCM)
Display	LCD
Communication connections	RS485, Optional: WIFI, Cellular
Warranty	10 years standard (extend to 20 years)

9. Specifications

Model	S6-GC33K-US
Max. DC input voltage (Volts)	1000
Rated DC voltage (Volts)	720
Start-up voltage (Volts)	180
MPPT voltage range (Volts)	160...1000
Full load MPPT voltage range (Volts)	580...850
Max. input current (Amps)	3x40
Max short circuit input current (Amps)	3x63
MPPT number/Max input strings number	3/6
Rated output power (Watts)	33000
Max. output power (Watts)	33000
Max. apparent output power (VA)	33000
Rated grid voltage (Volts)	3/PE~480
Max. output current (Amps)	39.7
Power Factor (at rated output power)	> 0.99 (0.8 leading - 0.8 lagging)
THDi (at rated output power)	<3%(at rated output power)
Rated grid frequency (Hertz)	60
Max. efficiency	98.8%
CEC efficiency	98.3%
Surge Protection	DC Type II / AC Type II
Integrated AFCI (DC arc-fault circuit protection)	YES
Integrated PID recovery	YES
Dimensions (W*H*D)	784*549*320 (mm) / 30.9x21.6x12.6 (inch)
Weight	43.7kg / 96.3lb
Topology	Transformerless
Self consumption (night)	< 1W
Operating ambient temperature range	-13...140°F / -25...+60°C
Storage environment	-40...176°F / -40...+80°C
Relative humidity	0~100%
Ingress protection	Type 4X
Noise emission	≤55dB(A)
Cooling concept	Intelligent redundant cooling
Max.operation altitude	13120ft / 4000m
Compliance	UL1741, UL1741SA, UL1741SB, Rule 21, UL1998 IEEE 1547, FCC Part 15 (Class A & B), UL1699B CAN/CSA C22.2 107.1-1, Rule 21 Phase II&III
DC connection	MC4 connectors
AC connection	OT Terminal connectors (Max . 250MCM)
Display	LCD
Communication connections	RS485, Optional: WIFI, Cellular
Warranty	10 years standard (extend to 20 years)

9. Specifications

Model	S6-GC36K-US
Max. DC input voltage (Volts)	1000
Rated DC voltage (Volts)	720
Start-up voltage (Volts)	180
MPPT voltage range (Volts)	160...1000
Full load MPPT voltage range (Volts)	580...850
Max. input current (Amps)	3x40
Max short circuit input current (Amps)	3x63
MPPT number/Max input strings number	3/6
Rated output power (Watts)	36000
Max. output power (Watts)	36000
Max. apparent output power (VA)	36000
Rated grid voltage (Volts)	3/PE~480
Max. output current (Amps)	43.3
Power Factor (at rated output power)	>0.99 (0.8 leading - 0.8 lagging)
THDi (at rated output power)	<3%(at rated output power)
Rated grid frequency (Hertz)	60
Max. efficiency	98.8%
CEC efficiency	98.3%
Surge Protection	DC Type II / AC Type II
Integrated AFCI (DC arc-fault circuit protection)	YES
Integrated PID recovery	YES
Dimensions (W*H*D)	784*549*320 (mm) / 30.9x21.6x12.6 (inch)
Weight	47.8kg / 105.4lb
Topology	Transformerless
Self consumption (night)	< 1W
Operating ambient temperature range	-13...140°F / -25...+60°C
Storage environment	-40...176°F / -40...+80°C
Relative humidity	0~100%
Ingress protection	Type 4X
Noise emission	≤55dB(A)
Cooling concept	Intelligent redundant cooling
Max.operation altitude	13120ft / 4000m
Compliance	UL1741, UL1741SA, UL1741SB, Rule 21, UL1998 IEEE 1547, FCC Part 15 (Class A & B), UL 1699B CAN/CSA C22.2 107.1-1, Rule 21 Phase II&III
DC connection	MC4 connectors
AC connection	OT Terminal connectors (Max . 250MCM)
Display	LCD
Communication connections	RS485, Optional: WIFI, Cellular
Warranty	10 years standard (extend to 20 years)

9. Specifications

Model	S6-GC40K-US
Max. DC input voltage (Volts)	1000
Rated DC voltage (Volts)	720
Start-up voltage (Volts)	180
MPPT voltage range (Volts)	160...1000
Full load MPPT voltage range (Volts)	580...850
Max. input current (Amps)	3x40
Max short circuit input current (Amps)	3x63
MPPT number/Max input strings number	3/6
Rated output power (Watts)	40000
Max. output power (Watts)	40000
Max. apparent output power (VA)	40000
Rated grid voltage (Volts)	3/PE~480
Max. output current (Amps)	48.1
Power Factor (at rated output power)	>0.99 (0.8 leading - 0.8 lagging)
THDi (at rated output power)	<3%(at rated output power)
Rated grid frequency (Hertz)	60
Max. efficiency	98.8%
CEC efficiency	98.3%
Surge Protection	DC Type II / AC Type II
Integrated AFCI (DC arc-fault circuit protection)	YES
Integrated PID recovery	YES
Dimensions (W*H*D)	784*549*320 (mm) / 30.9x21.6x12.6 (inch)
Weight	47.8kg / 105.4lb
Topology	Transformerless
Self consumption (night)	< 1W
Operating ambient temperature range	-13...140°F / -25...+60°C
Storage environment	-40...176°F / -40...+80°C
Relative humidity	0~100%
Ingress protection	Type 4X
Noise emission	≤55dB(A)
Cooling concept	Intelligent redundant cooling
Max.operation altitude	13120ft / 4000m
Compliance	UL1741, UL1741SA, UL1741SB, Rule 21, UL1998 IEEE 1547, FCC Part 15 (Class A & B), UL1699B CAN/CSA C22.2 107.1-1, Rule 21 Phase II&III
DC connection	MC4 connectors
AC connection	OT Terminal connectors (Max . 250MCM)
Display	LCD
Communication connections	RS485, Optional: WIFI, Cellular
Warranty	10 years standard (extend to 20 years)

9. Specifications

Model	S6-GC50K-US
Max. DC input voltage (Volts)	1000
Rated DC voltage (Volts)	720
Start-up voltage (Volts)	180
MPPT voltage range (Volts)	160...1000
Full load MPPT voltage range (Volts)	580...850
Max. input current (Amps)	4x40
Max short circuit input current (Amps)	4x63
MPPT number/Max input strings number	4/8
Rated output power (Watts)	50000
Max. output power (Watts)	50000
Max. apparent output power (VA)	50000
Rated grid voltage (Volts)	3/PE~480
Max. output current (Amps)	60.1
Power Factor (at rated output power)	>0.99 (0.8 leading - 0.8 lagging)
THDi (at rated output power)	<3%(at rated output power)
Rated grid frequency (Hertz)	60
Max. efficiency	98.8%
CEC efficiency	98.3%
Surge Protection	DC Type II / AC Type II
Integrated AFCI (DC arc-fault circuit protection)	YES
Integrated PID recovery	YES
Dimensions (W*H*D)	784*549*320 (mm) / 30.9x21.6x12.6 (inch)
Weight	49.3kg / 108.7lb
Topology	Transformerless
Self consumption (night)	< 1W
Operating ambient temperature range	-13...140°F / -25...+60°C
Storage environment	-40...176°F / -40...+80°C
Relative humidity	0~100%
Ingress protection	Type 4X
Noise emission	≤55dB(A)
Cooling concept	Intelligent redundant cooling
Max.operation altitude	13120ft / 4000m
Compliance	UL1741, UL1741SA, UL1741SB, Rule 21, UL1998 IEEE 1547, FCC Part 15 (Class A & B), UL1699B CAN/CSA C22.2 107.1-1, Rule 21 Phase II&III
DC connection	MC4 connectors
AC connection	OT Terminal connectors (Max . 250MCM)
Display	LCD
Communication connections	RS485, Optional: WIFI, Cellular
Warranty	10 years standard (extend to 20 years)

9. Specifications

Model	S6-GC60K-US
Max. DC input voltage (Volts)	1000
Rated DC voltage (Volts)	720
Start-up voltage (Volts)	180
MPPT voltage range (Volts)	160...1000
Full load MPPT voltage range (Volts)	550...850
Max. input current (Amps)	4x40
Max short circuit input current (Amps)	4x63
MPPT number/Max input strings number	4/8
Rated output power (Watts)	60000
Max. output power (Watts)	60000
Max. apparent output power (VA)	60000
Rated grid voltage (Volts)	3/PE~480
Max. output current (Amps)	72.2
Power Factor (at rated output power)	>0.99 (0.8 leading - 0.8 lagging)
THDi (at rated output power)	<3%(at rated output power)
Rated grid frequency (Hertz)	60
Max. efficiency	98.8%
CEC efficiency	98.3%
Surge Protection	DC Type II / AC Type II
Integrated AFCI (DC arc-fault circuit protection)	YES
Integrated PID recovery	YES
Dimensions (W*H*D)	784*549*320 (mm) / 30.9x21.6x12.6 (inch)
Weight	50.1kg / 110.5lb
Topology	Transformerless
Self consumption (night)	< 1W
Operating ambient temperature range	-13...140°F / -25...+60°C
Storage environment	-40...176°F / -40...+80°C
Relative humidity	0~100%
Ingress protection	Type 4X
Noise emission	≤55dB(A)
Cooling concept	Intelligent redundant cooling
Max.operation altitude	13120ft / 4000m
Compliance	UL1741, UL1741SA, UL1741SB, Rule 21, UL1998 IEEE 1547, FCC Part 15 (Class A & B), UL1699B CAN/CSA C22.2 107.1-1, Rule 21 Phase II&III
DC connection	MC4 connectors
AC connection	OT Terminal connectors (Max . 250MCM)
Display	LCD
Communication connections	RS485, Optional: WIFI, Cellular
Warranty	10 years standard (extend to 20 years)

9. Specifications

Model	S6-GC30K-LV-US
Max. DC input voltage (Volts)	1000
Rated DC voltage (Volts)	600
Start-up voltage (Volts)	195
MPPT voltage range (Volts)	180...1000
Full load MPPT voltage range (Volts)	340...680
Max. input current (Amps)	3x40
Max short circuit input current (Amps)	3x63
MPPT number/Max input strings number	3/6
Rated output power (Watts)	30000
Max. output power (Watts)	30000
Max. apparent output power (VA)	30000
Rated grid voltage (Volts)	3/PE~208
Max. output current (Amps)	83.3
Power Factor (at rated output power)	>0.99 (0.8 leading - 0.8 lagging)
THDi (at rated output power)	<3%(at rated output power)
Rated grid frequency (Hertz)	60
Max. efficiency	97.7%
CEC efficiency	97.0%
Surge Protection	DC Type II / AC Type II
Integrated AFCI (DC arc-fault circuit protection)	YES
Integrated PID recovery	YES
Dimensions (W*H*D)	784*549*320 (mm) / 30.9x21.6x12.6 (inch)
Weight	47.1kg / 103.8lb
Topology	Transformerless
Self consumption (night)	< 1W
Operating ambient temperature range	-13...140°F / -25...+60°C
Storage environment	-40...176°F / -40...+80°C
Relative humidity	0~100%
Ingress protection	Type 4X
Noise emission	≤55dB(A)
Cooling concept	Intelligent redundant cooling
Max.operation altitude	13120ft / 4000m
Compliance	UL1741, UL1741SA, UL1741SB, Rule 21, UL1998 IEEE 1547, FCC Part 15 (Class A & B), UL1699B CAN/CSA C22.2 107.1-1, Rule 21 Phase II&III
DC connection	MC4 connectors
AC connection	OT Terminal connectors (Max . 250MCM)
Display	LCD
Communication connections	RS485, Optional: WIFI, Cellular
Warranty	10 years standard (extend to 20 years)

Parts	Torque
Cover screws	1.5-1.7 ft.lbs
Ground screws (Cover)	4.4-6.0 ft.lbs
Ground screws (Internal)	11-15 ft.lbs
AC terminals	11-15 ft.lbs

10.1 Temperature Derating Curve

This chart describes the S6-GC(25-40)K-US inverter's Derating curve vs. Ambient temperature.

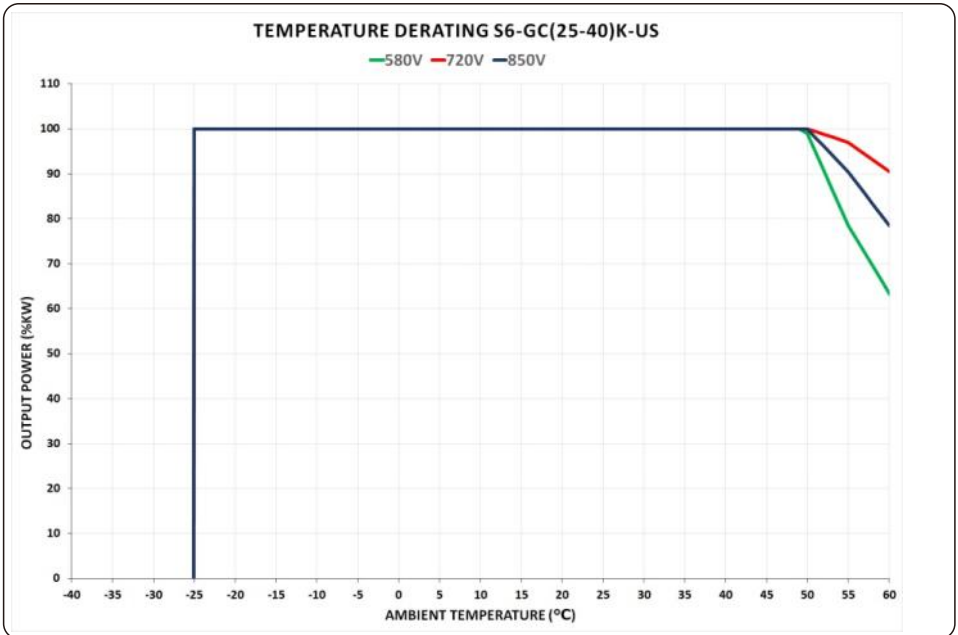

This document describes the S6-GC(50-60K-US inverter's Derating curve vs. Ambient temperature.

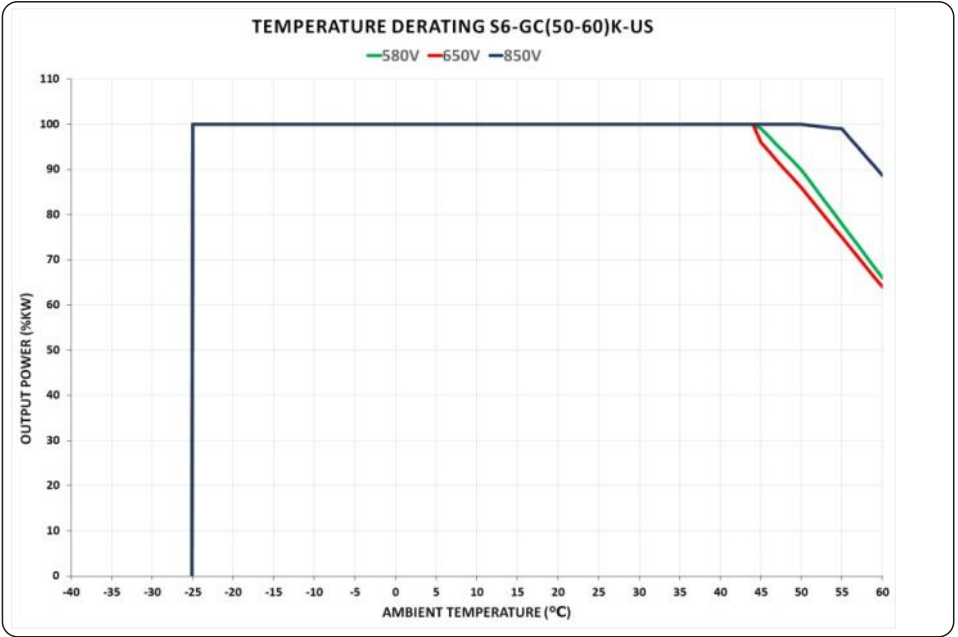

This document describes the S6-GC30K-LV-US inverter's Derating curve vs. Ambient temperature.

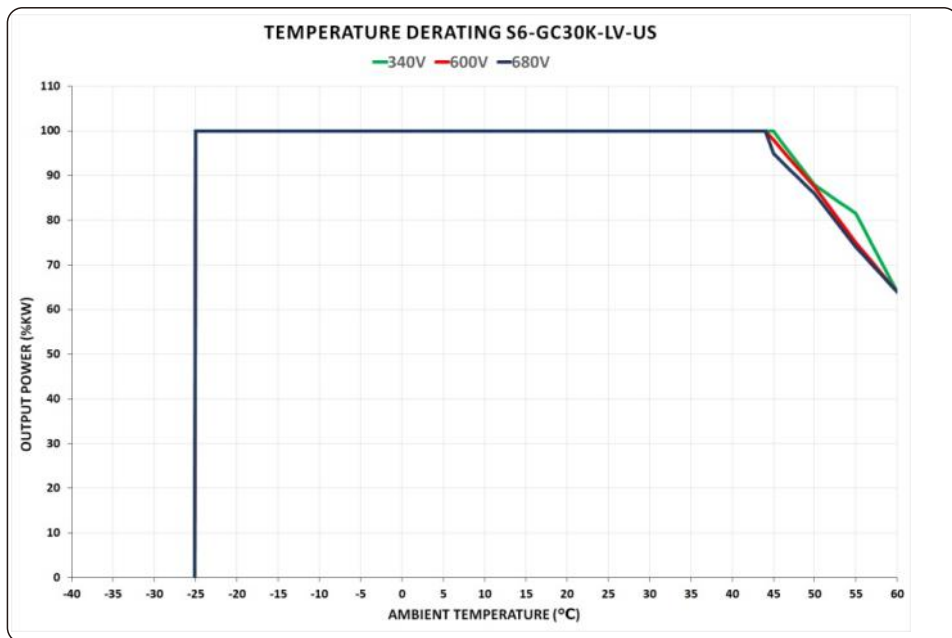

10.2 Input Voltage Derating

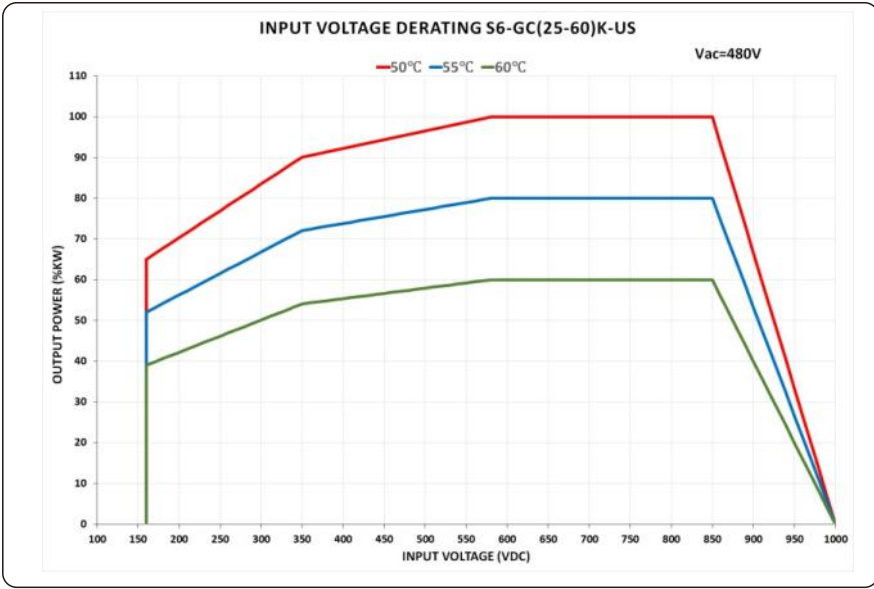

10.3 Output Voltage Derating

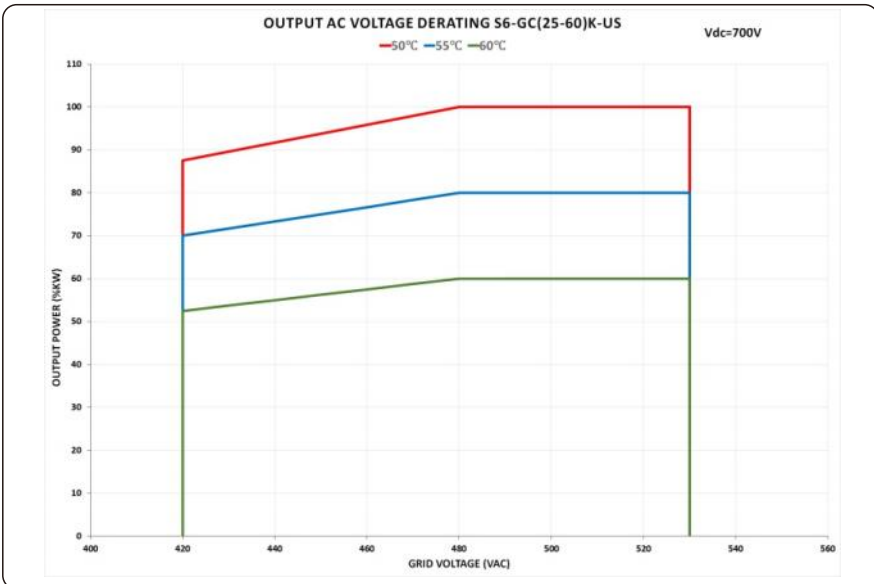

10.4 Input Voltage Derating

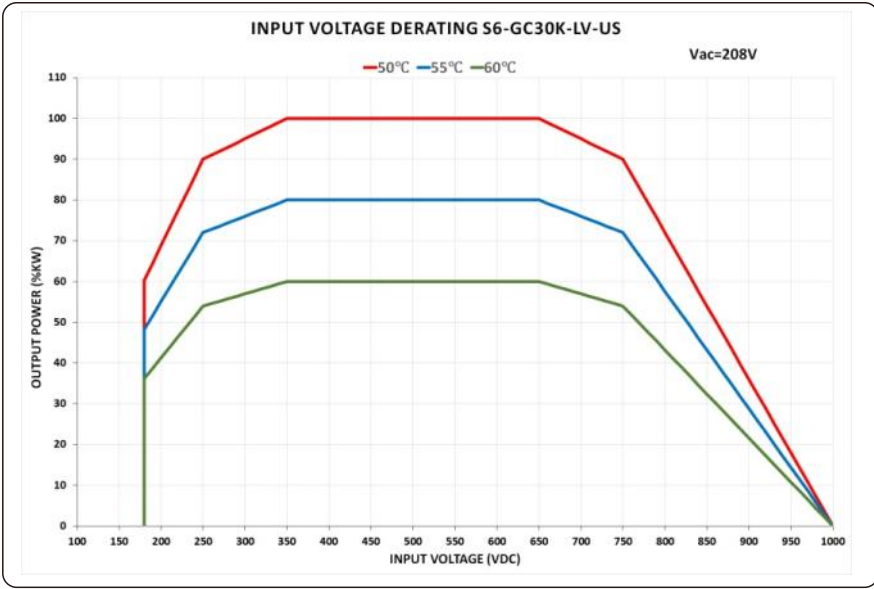

10.5 Output Voltage Derating

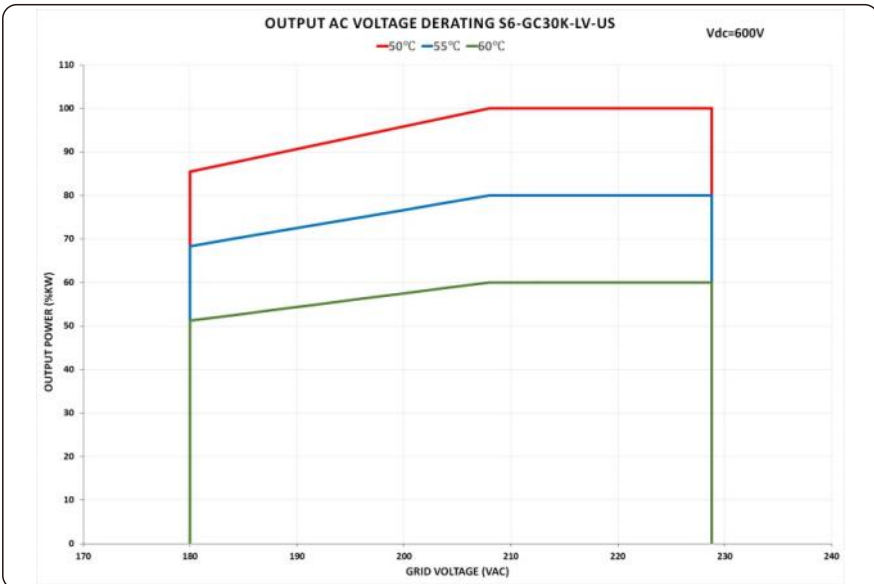

10.6 P-Q Capabilities at Nominal Output Power

Inverter is capable providing reactive power of $\pm 36\text{kVAR}$ at nominal grid voltage and rated ambient temperature. Chart below details inverter reactive power capabilities at various input voltages and various ambient temperature conditions.

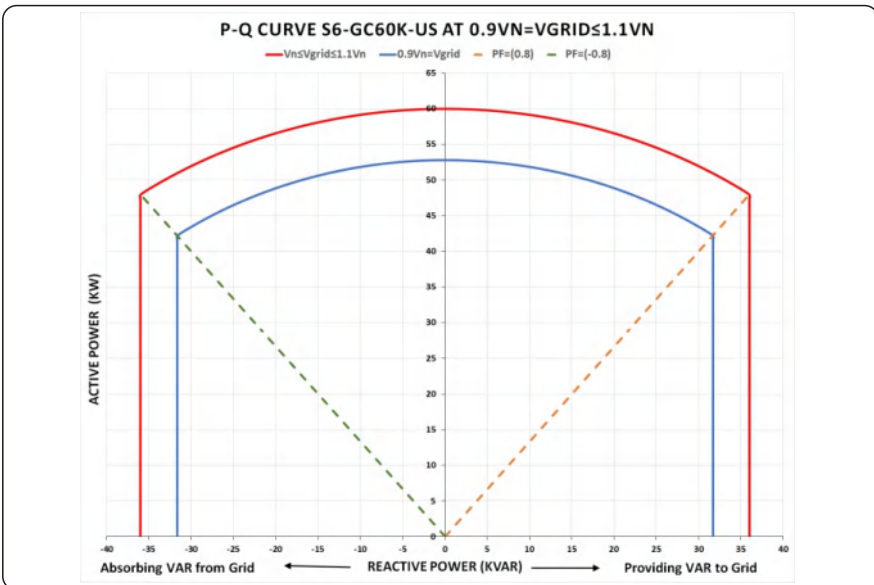
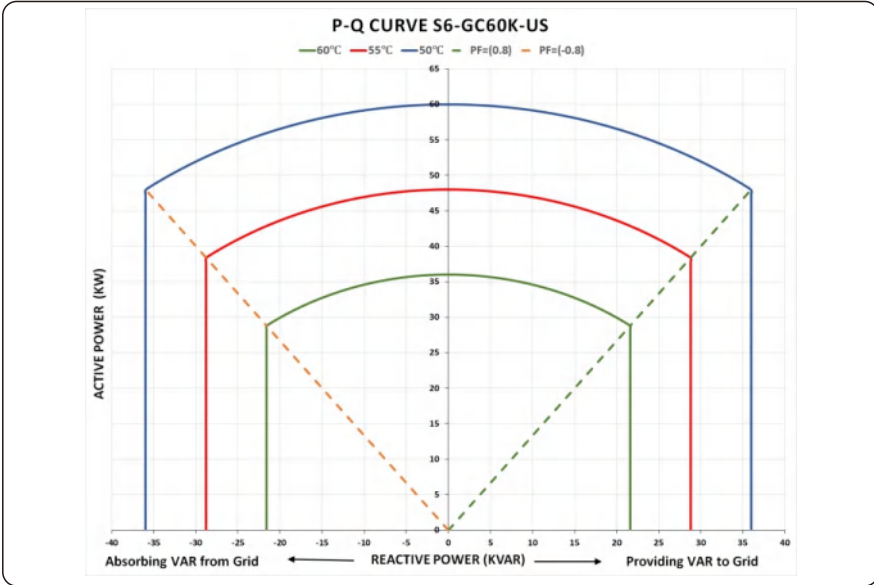

10.7 P-Q Capabilities at Nominal Output Power

Inverter is capable providing reactive power of $\pm 30\text{kVAR}$ at nominal grid voltage and rated ambient temperature. Chart below details inverter reactive power capabilities at various input voltages and various ambient temperature conditions.

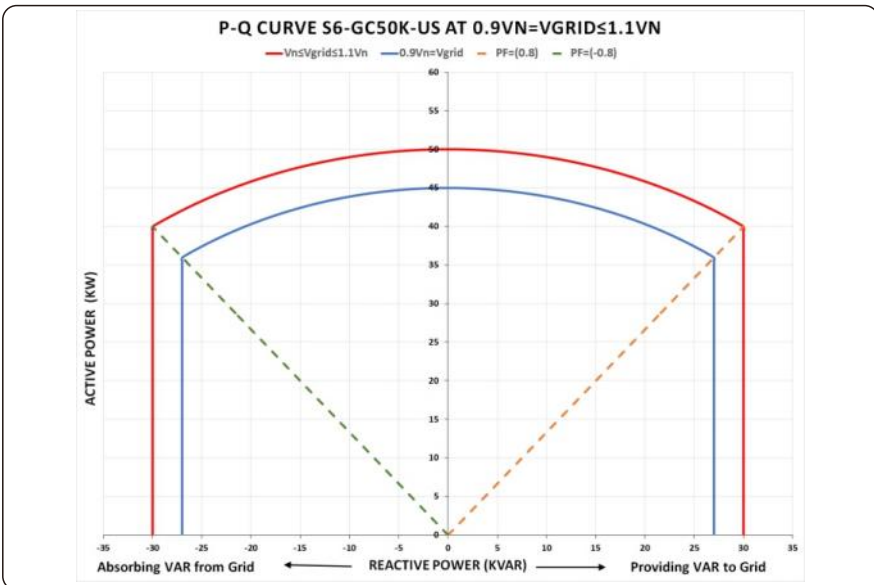
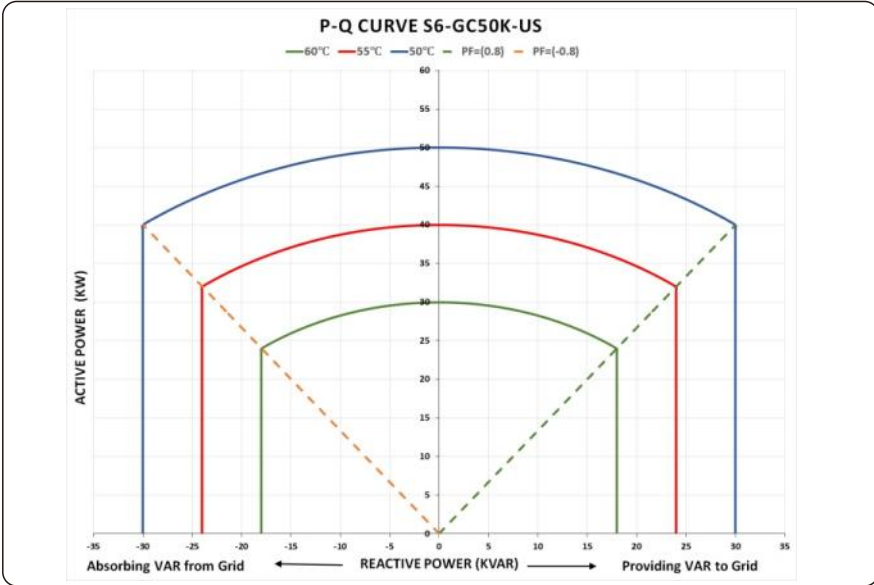

10.8 P-Q Capabilities at Nominal Output Power

Inverter is capable providing reactive power of $\pm 24\text{kVAR}$ at nominal grid voltage and rated ambient temperature. Chart below details inverter reactive power capabilities at various input voltages and various ambient temperature conditions.

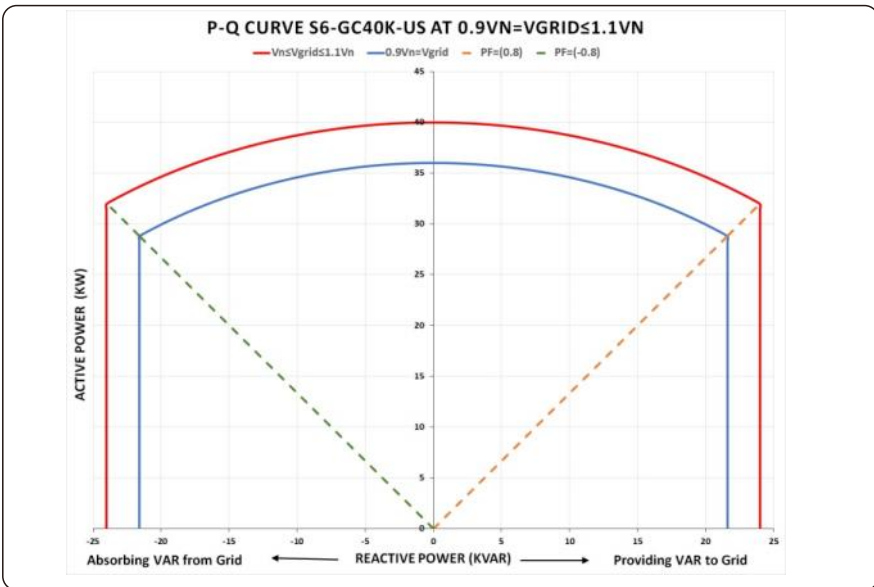
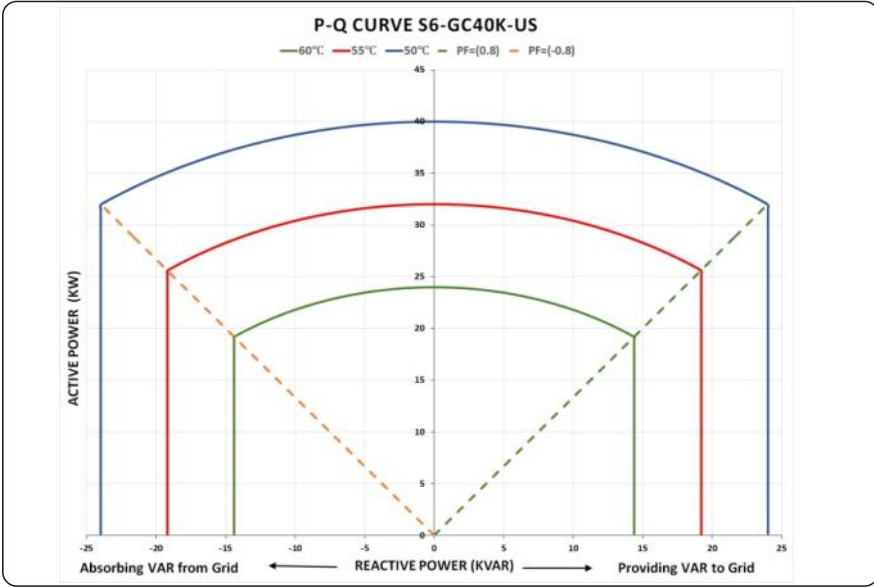

10.9 P-Q Capabilities at Nominal Output Power

Inverter is capable providing reactive power of ± 21.6 kVAR at nominal grid voltage and rated ambient temperature. Chart below details inverter reactive power capabilities at various input voltages and various ambient temperature conditions.

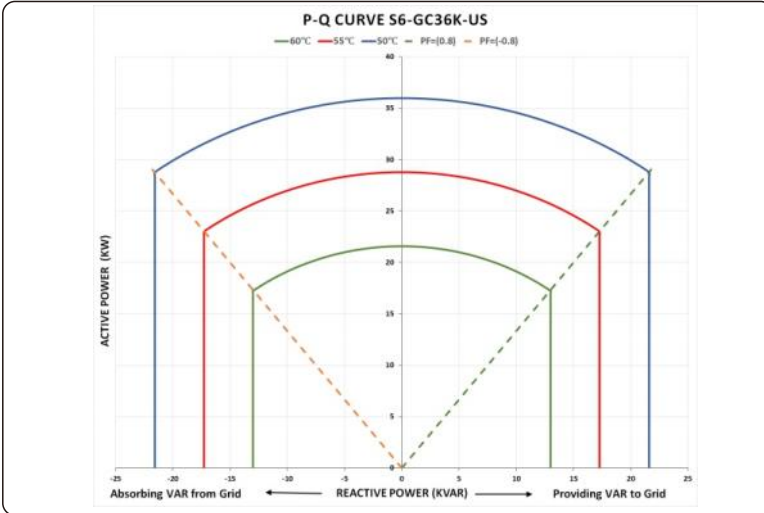

10.10 P-Q Capabilities at Nominal Output Power

Inverter is capable providing reactive power of ± 19.8 kVAR at nominal grid voltage and rated ambient temperature. Chart below details inverter reactive power capabilities at various input voltages and various ambient temperature conditions.

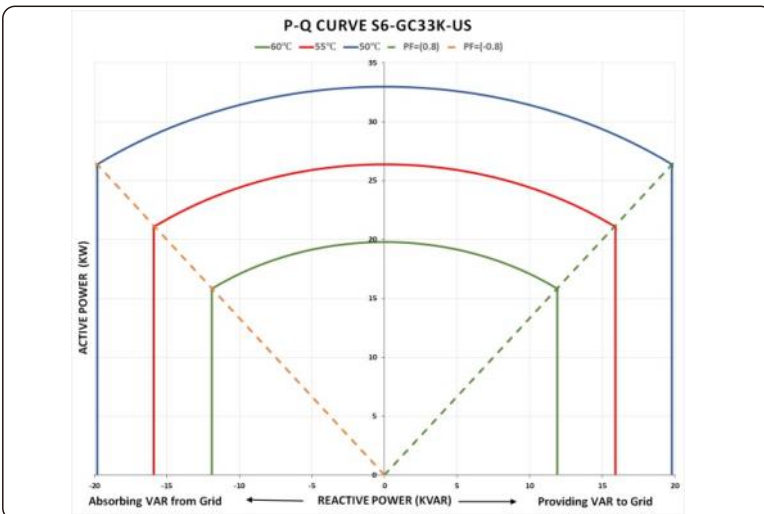

10.11 P-Q Capabilities at Nominal Output Power

Inverter is capable providing reactive power of $\pm 15\text{kVAR}$ at nominal grid voltage and rated ambient temperature. Chart below details inverter reactive power capabilities at various input voltages and various ambient temperature conditions.

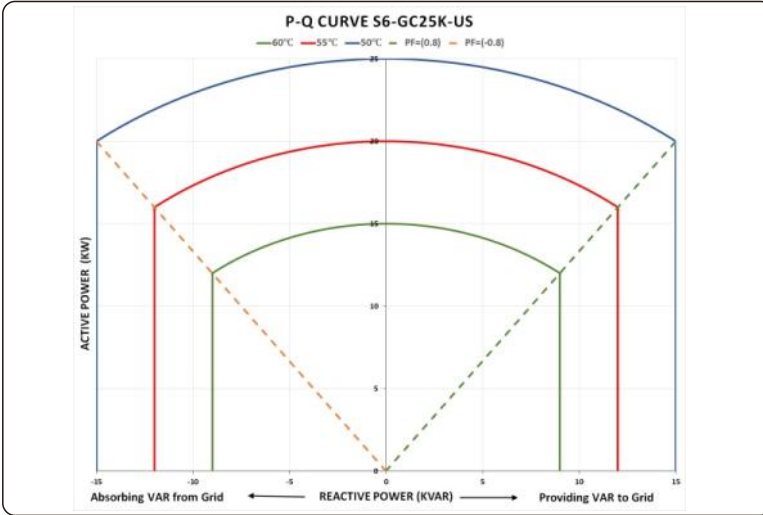

10.12 P-Q Capabilities at Nominal Output Power

Inverter is capable providing reactive power of $\pm 18\text{kVAR}$ at nominal grid voltage and rated ambient temperature. Chart below details inverter reactive power capabilities at various input voltages and various ambient temperature conditions.

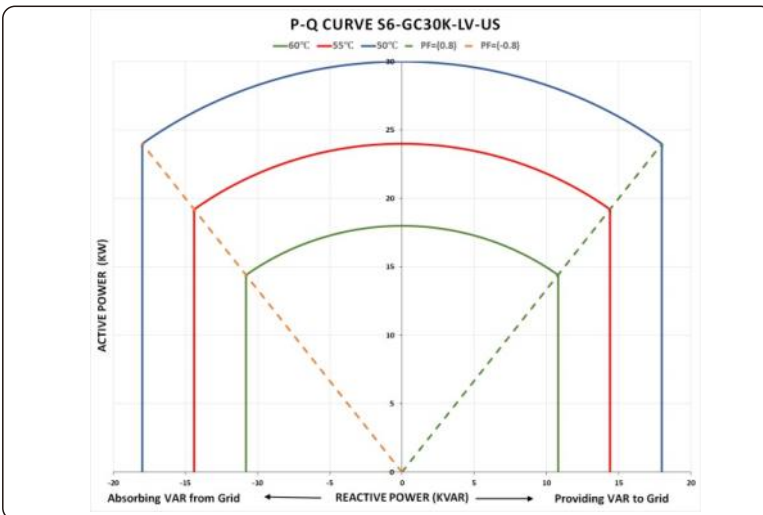

10.13 Default Grid Setting for IEEE1547-2018

Parameter	Adjustment Range (pu)	Default (pu)	Description
OV-G-V01	$1.10 \leq V \leq 1.21$	$1.10V_n$	Set grid over-voltage protection 01 value
OV-G-V01-T	$0.1 \leq t \leq 13$ S	13 S	Grid over-voltage protection 01 trip time
OV-G-V02	$1.20 \leq V \leq 1.30$	$1.20V_n$	Set grid over-voltage protection 02 value
OV-G-V02-T	$0.1 \leq t \leq 5$ S	0.16 S	Grid over-voltage protection 02 trip time
UN-G-V01	$0.05 \leq V \leq 0.88$	$0.88V_n$	Set grid under-voltage protection 01 value
UN-G-V01-T	$2.0 \leq t \leq 50$ S	21 S	Grid under-voltage protection 01 trip time
UN-G-V02	$0.05 \leq V \leq 0.70$	$0.5V_n$	Set grid under-voltage protection 02 value
UN-G-V02-T	$0.16 \leq t \leq 21$ S	2 S	Grid under-voltage protection 02 trip time
UN-G-V03	$0.05 \leq V \leq 0.50$	$0.5V_n$	Set grid under-voltage protection 03 value
UN-G-V03-T	$0.16 \leq t \leq 21$ S	2 S	Grid under-voltage protection 03 trip time
OV-G-F01	$60.5 \leq f \leq 66$ Hz	61.2 Hz	Set grid over-frequency protection 01 value
OV-G-F01-T	$180 \leq t \leq 1000$ S	300 S	Set grid over-frequency protection 01 trip time
OV-G-F02	$61.2 \leq f \leq 66$ Hz	62 Hz	Set grid over-frequency protection 02 value
OV-G-F02-T	$0.16 \leq t \leq 1000$ S	0.16 S	Set grid over-frequency protection 02 trip time
UN-G-F01	$50 \leq f \leq 59$ Hz	58.5 Hz	Set grid under-frequency protection 01 value
UN-G-F01-T	$180 \leq t \leq 1000$ S	300 S	Set grid under-frequency protection 01 trip time
UN-G-F02	$50 \leq f \leq 58$ Hz	56.5 Hz	Set grid under-frequency protection 02 value
UN-G-F02-T	$0.16 \leq t \leq 1000$ S	0.16 S	Set grid under-frequency protection 02 trip time
Reconnection Voltage	$0.88 \leq V \leq 0.95$ $1.05 \leq V \leq 1.06$	$0.917V_n$ $1.05V_n$	Set grid recovery voltage range after grid fault
Reconnection Frequency	$59 \leq f \leq 59.9$ $60.1 \leq f \leq 61$	59.5 Hz 60.1 Hz	Set grid recovery frequency range after grid fault
Reconnection Time after Fault	$0 \leq t \leq 600$ S	300 S	Set reconnection time after a fault is cleared
Ramp-up Slew Rate	0.10-100%	100% Pn/S	Set Ramp-up power slew rate during start-up
Reconnect Slew Rate	0.10-100%	0.33% Pn/S	Set Ramp-up power slew rate during reconnect

10.13 Default Grid Setting for IEEE1547-2018

Parameter	Adjustment Range (pu)	Default (pu)	Description
Volt Watt P3Tau	$0.5 \leq t \leq 60$ S	10 S	Set the time to ramp up to 90% of the new active power target in response to the change in voltage
Volt Var Q3Tau	$1 \leq t \leq 90$ S	5 S	Set the time to ramp up to 90% of the new reactive power target in response to the change in voltage
Dead Band-OF	$60.017 \leq f \leq 61$ Hz	60.036Hz	Set OF frequency start dead band for power derate
Droop-OF	2-5 %	5 %	Set OF frequency derate droop slope
Response Time	$0.2 \leq t \leq 10$ S	5 S	Set frequency derate response time
Dead Band-UF	$59 \leq f \leq 59.983$ Hz	59.964 Hz	Set UF frequency start dead band for power derate
Droop-UF	2-5 %	5 %	Set UF frequency derate droop slope
Droop Pmin	0-100 %	0 %	Set frequency droop P minimum
Volt-Watt	Enabled/ Disabled	Enabled	Set Volt - Watt function
V1	Hybrid: $0.40 \leq V \leq 1.00$ Grid-tied: $0.90 \leq V \leq 1.30$	Hybrid: $0.50V_n$ Grid-tied: $1.00V_n$	Set grid voltage V1 limit for Volt-Watt control
P1	0-100 % Pn	100% Pn	Set power P1 for Volt-Watt control
V2	Hybrid: $0.60 \leq V \leq 1.05$ Grid-tied: $1.00 \leq V \leq 1.35$	Hybrid: $0.70V_n$ Grid-tied: $1.00V_n$	Set grid voltage V2 limit for Volt-Watt control
P2	0-100 % Pn	100% Pn	Set power P2 for Volt-Watt control
V3	$1.05 \leq V \leq 1.09$	$1.06V_n$	Set grid voltage V3 limit for Volt-Watt control
P3	0-100 % Pn	100% Pn	Set power P3 for Volt-Watt control
V4	$1.06 \leq V \leq 1.10$	$1.10V_n$	Set grid voltage V4 limit for Volt-Watt control
P4	0-100 % Pn	Hybrid: 0 Grid-tied: 20%Pn	Set power P4 for Volt-Watt control
Volt-Var	Enabled/ Disabled	Enable	Set Volt-Var function
V1	$0.77 \leq V \leq 1.03$	$0.92V_n$	Set grid voltage V1 limit for Volt-Var control
Q1	0-60% Sn	+44% Sn	Set reactive power Q1 for Volt-Var control
V2	$0.92 \leq V \leq 1.05$	$0.98V_n$	Set grid voltage V2 limit for Volt-Var control
Q2	-60-60% Sn	0% Sn	Set reactive power Q2 for Volt-Var control
V3	$0.95 \leq V \leq 1.08$	$1.02V_n$	Set grid voltage V3 limit for Volt-Var control
Q3	-60-60% Sn	0% Sn	Set reactive power Q3 for Volt-Var control
V4	$0.97 \leq V \leq 1.23$	$1.08V_n$	Set grid voltage V4 limit for Volt-Var control
Q4	-60-0% Sn	-44% Sn	Set reactive power Q4 for Volt-Var control
Fixed PF	-0.8 -+0.8	1.0	Set Fixed Power Factor limit
Reactive Power	-60 -60 %	0%	Set Reactive Power level

10.14 Default Grid Setting for RULE 21

Parameter	Adjustment Range (pu)	Default (pu)	Description
OV-G-V01	$1.10 \leq V \leq 1.21$	$1.10V_n$	Set grid over-voltage protection 01 value
OV-G-V01-T	$0.1 \leq t \leq 13$ S	13 S	Grid over-voltage protection 01 trip time
OV-G-V02	$1.20 \leq V \leq 1.30$	$1.20V_n$	Set grid over-voltage protection 02 value
OV-G-V02-T	$0.1 \leq t \leq 5$ S	0.16 S	Grid over-voltage protection 02 trip time
UN-G-V01	$0.05 \leq V \leq 0.88$	$0.88V_n$	Set grid under-voltage protection 01 value
UN-G-V01-T	$2.0 \leq t \leq 50$ S	21 S	Grid under-voltage protection 01 trip time
UN-G-V02	$0.05 \leq V \leq 0.70$	$0.5V_n$	Set grid under-voltage protection 02 value
UN-G-V02-T	$0.16 \leq t \leq 21$ S	2 S	Grid under-voltage protection 02 trip time
UN-G-V03	$0.05 \leq V \leq 0.50$	$0.5V_n$	Set grid under-voltage protection 03 value
UN-G-V03-T	$0.16 \leq t \leq 21$ S	2 S	Grid under-voltage protection 03 trip time
OV-G-F01	$60.5 \leq f \leq 66$ Hz	61.2 Hz	Set grid over-frequency protection 01 value
OV-G-F01-T	$180 \leq t \leq 1000$ S	300 S	Set grid over-frequency protection 01 trip time
OV-G-F02	$61.2 \leq f \leq 66$ Hz	62 Hz	Set grid over-frequency protection 02 value
OV-G-F02-T	$0.16 \leq t \leq 1000$ S	0.16 S	Set grid over-frequency protection 02 trip time
UN-G-F01	$50 \leq f \leq 59$ Hz	58.5 Hz	Set grid under-frequency protection 01 value
UN-G-F01-T	$180 \leq t \leq 1000$ S	300 S	Set grid under-frequency protection 01 trip time
UN-G-F02	$50 \leq f \leq 58$ Hz	56.5 Hz	Set grid under-frequency protection 02 value
UN-G-F02-T	$0.16 \leq t \leq 1000$ S	0.16 S	Set grid under-frequency protection 02 trip time
Reconnection Voltage	$0.88 \leq V \leq 0.95$ $1.05 \leq V \leq 1.06$	$0.917V_n$ $1.05V_n$	Set grid recovery voltage range after grid fault
Reconnection Frequency	$59 \leq f \leq 59.9$ $60.1 \leq f \leq 61$	59.5Hz 60.1Hz	Set grid recovery frequency range after grid fault
Reconnection Time after Fault	$0 \leq t \leq 600$ S	300 S	Set reconnection time after a fault is cleared
Ramp-up Slew Rate	0.10-100%	100%Pn/S	Set Ramp-up power slew rate during start-up
Reconnect Slew Rate	0.10-100%	0.33%Pn/S	Set Ramp-up power slew rate during reconnect

10.14 Default Grid Setting for RULE 21

Parameter	Adjustment Range (pu)	Default (pu)	Description
Volt Watt P3Tau	$0.5 \leq t \leq 60$ S	10 S	Set the time to ramp up to 90% of the new active power target in response to the change in voltage
Volt Var Q3Tau	$1 \leq t \leq 90$ S	5 S	Set the time to ramp up to 90% of the new reactive power target in response to the change in voltage
Dead Band-OF	$60.017 \leq f \leq 61$ Hz	60.036Hz	Set OF frequency start dead band for power derate
Droop-OF	2-5 %	5 %	Set OF frequency derate droop slope
Response Time	$0.2 \leq t \leq 10$ S	5 S	Set frequency derate response time
Dead Band-UF	$59 \leq f \leq 59.983$ Hz	59.964 Hz	Set UF frequency start dead band for power derate
Droop-UF	2-5 %	5 %	Set UF frequency derate droop slope
Droop Pmin	0-100 %	0 %	Set frequency droop P minimum
Volt-Watt	Enabled/ Disabled	Enabled	Set Volt - Watt function
V1	Hybrid: $0.40 \leq V \leq 1.00$ Grid-tied: $0.90 \leq V \leq 1.30$	Hybrid: 1.00Vn Grid-tied: 1.00Vn	Set grid voltage V1 limit for Volt-Watt control
P1	0-100 % Pn	100% Pn	Set power P1 for Volt-Watt control
V2	Hybrid: $0.60 \leq V \leq 1.05$ Grid-tied: $1.00 \leq V \leq 1.35$	Hybrid: 1.00Vn Grid-tied: 1.00Vn	Set grid voltage V2 limit for Volt-Watt control
P2	0-100 % Pn	100% Pn	Set power P2 for Volt-Watt control
V3	$1.05 \leq V \leq 1.09$	1.06Vn	Set grid voltage V3 limit for Volt-Watt control
P3	0-100 % Pn	100% Pn	Set power P3 for Volt-Watt control
V4	$1.06 \leq V \leq 1.10$	1.10Vn	Set grid voltage V4 limit for Volt-Watt control
P4	0-100 % Pn	Hybrid: 0%Pn Grid-tied: 0%Pn	Set power P4 for Volt-Watt control
Volt-Var	Enabled/ Disabled	Enable	Set Volt-Var function
V1	$0.77 \leq V \leq 1.03$	0.92Vn	Set grid voltage V1 limit for Volt-Var control
Q1	0-60% Sn	+30% Sn	Set reactive power Q1 for Volt-Var control
V2	$0.92 \leq V \leq 1.05$	0.97Vn	Set grid voltage V2 limit for Volt-Var control
Q2	-60-60% Sn	0% Sn	Set reactive power Q2 for Volt-Var control
V3	$0.95 \leq V \leq 1.08$	1.03Vn	Set grid voltage V3 limit for Volt-Var control
Q3	-60-60% Sn	0% Sn	Set reactive power Q3 for Volt-Var control
V4	$0.97 \leq V \leq 1.23$	1.07Vn	Set grid voltage V4 limit for Volt-Var control
Q4	-60-0% Sn	-30% Sn	Set reactive power Q4 for Volt-Var control
Fixed PF	-0.8 +0.8	1.0	Set Fixed Power Factor limit
Reactive Power	-60 -60 %	0%	Set Reactive Power level

10.15 Voltage and Frequency Protection Settings for 208VAC grid

Parameter	Adjustment Range V/pu/S/Hz		Default V/pu/S/Hz	
OV-G-V01	$132 \leq V \leq 145.3$	$1.10 \leq V \leq 1.21$	132V	1.10Vn
OV-G-V01-T	$0.1 \leq t \leq 13$ S		13 S	
OV-G-V02	$144 \leq V \leq 156$	$1.20 \leq V \leq 1.30$	144V	1.20Vn
OV-G-V02-T	$0.1 \leq t \leq 5$ S		0.16 S	
UN-G-V01	$6 \leq V \leq 105.6$	$0.05 \leq V \leq 0.88$	105.6V	0.88Vn
UN-G-V01-T	$2.0 \leq t \leq 50$ S		21 S	
UN-G-V02	$6 \leq V \leq 84$	$0.05 \leq V \leq 0.70$	60V	0.5Vn
UN-G-V02-T	$0.16 \leq t \leq 21$ S		2 S	
UN-G-V03	$6 \leq V \leq 60$	$0.05 \leq V \leq 0.50$	60V	0.5Vn
UN-G-V03-T	$0.16 \leq t \leq 21$ S		2 S	
OV-G-F01	$60.5 \leq f \leq 66$ Hz		61.2 Hz	
OV-G-F01-T	$180 \leq t \leq 1000$ S		300 S	
OV-G-F02	$61.2 \leq f \leq 66$ Hz		62 Hz	
OV-G-F02-T	$0.16 \leq t \leq 1000$ S		0.16 S	
UN-G-F01	$50 \leq f \leq 59$ Hz		58.5 Hz	
UN-G-F01-T	$180 \leq t \leq 1000$ S		300 S	
UN-G-F02	$50 \leq f \leq 58$ Hz		56.5 Hz	
UN-G-F02-T	$0.16 \leq t \leq 1000$ S		0.16 S	

10.16 Voltage and Frequency Ride Through Settings

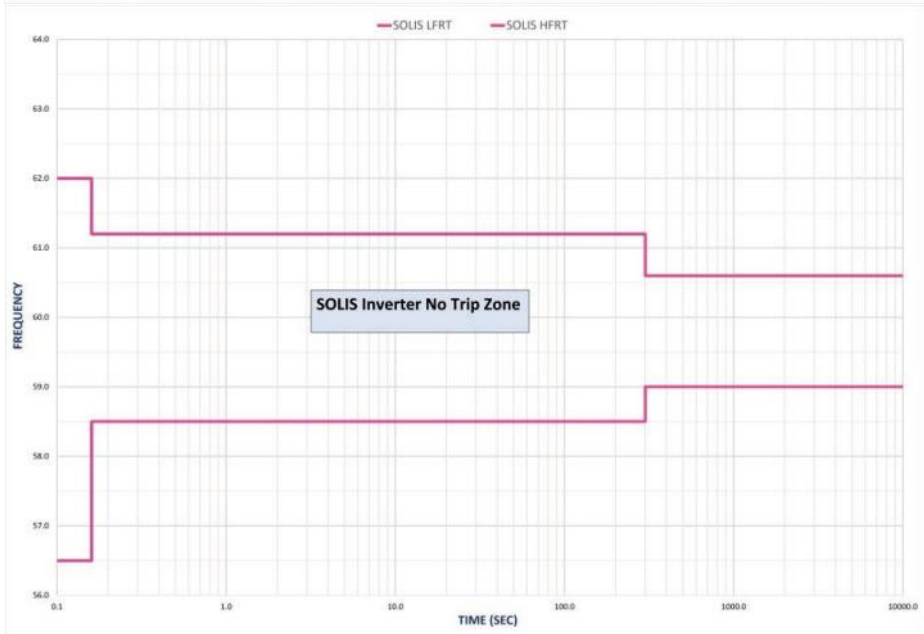
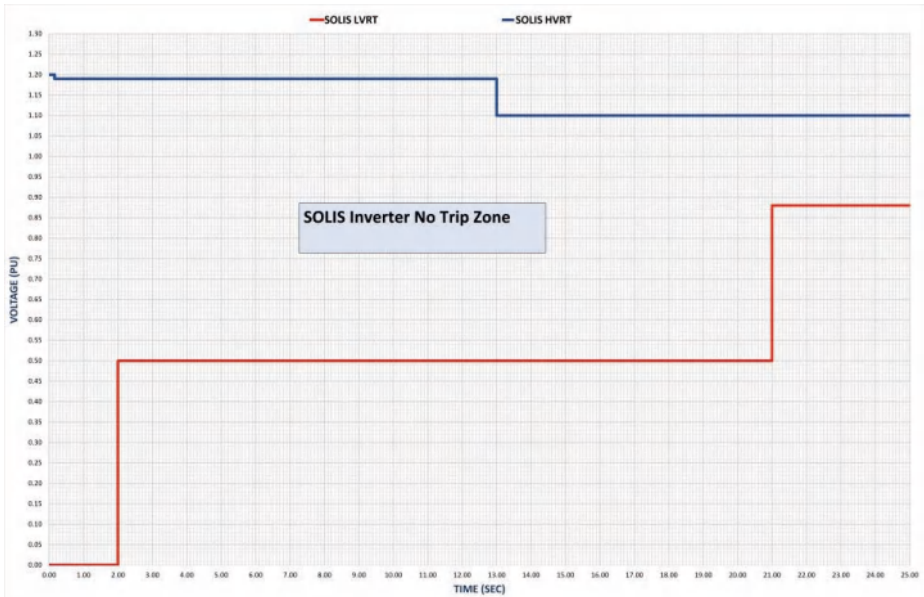

10.17 VOLT - VAR IEEE1547-2018 Setting



10.18 VOLT - WATT IEEE1547-2018 Setting



10.19 FREQUENCY DROOP Setting

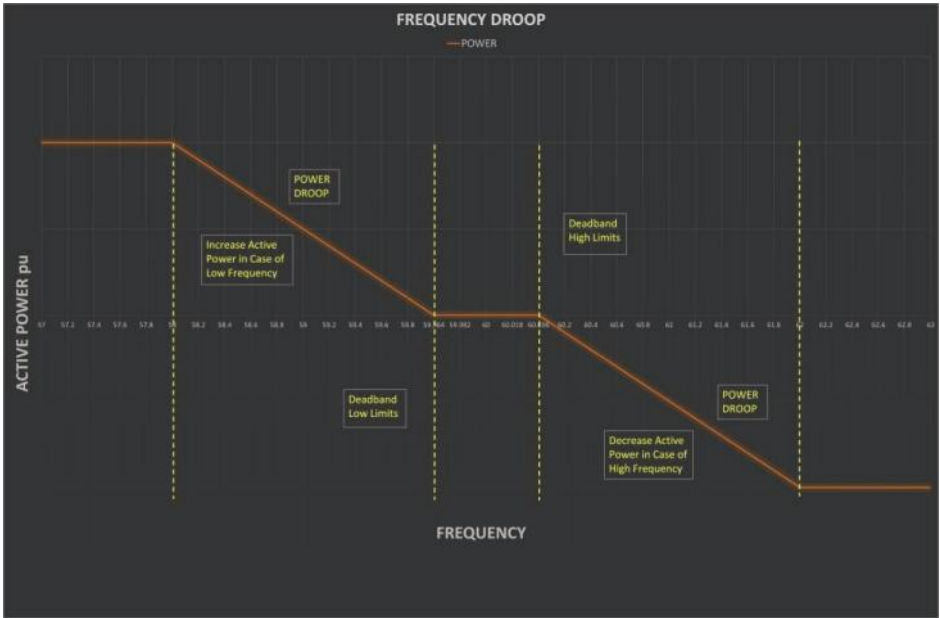

10.20 Product Certificate of Compliance

			
<h1>Certificate of Compliance</h1>			
Certificate:	80062600	Master Contract:	273488
Project:	80173205	Date Issued:	2023-09-15
Issued to:	Ginlong Technologies Co., Ltd. No. 57, Jintong Road, Xiangshan Ningbo, Zhejiang, 315712 CHINA Attention: Ruyi Pan		
<p><i>The products listed below are eligible to bear the CSA Mark shown with adjacent indicators 'C' and 'US' for Canada and US or with adjacent indicator 'US' for US only or without either indicator for Canada only</i></p>			
		Issued by: <i>Magic Zhang</i> Magic Zhang	
<u>PRODUCTS</u>			
CLASS - C531109 - POWER SUPPLIES - Distributed Generation Power Systems Equipment			
CLASS - C531189 - POWER SUPPLIES - Distributed Generation-Power Systems Equipment - Certified to U.S. Standards			
Transformerless Utility Interactive PV Inverter, Models Solis-15K-LV-5G, Solis-20K-LV-5G, Solis-23K-LV-5G, Solis-40K-HV-5G, Solis-50K-HV-5G and S5-GC15K-LV, S5-GC20K-LV, S5-GC23K-LV, S5-GC40K-HV, S5-GC50K-HV, permanently connected.			
Transformerless Grid Support Utility Interactive PV Inverter, Models S6-GC25K-US, S6-GC30K-US, S6-GC33K-US, S6-GC36K-US, S6-GC40K-US, S6-GC50K-US, S6-GC60K-US and S6-GC30K-LV-US, permanently connected.			
For details related to rating, size, configuration, etc., reference should be made to the CSA Certification Record, Certificate of Compliance, Annex A, or the Descriptive Report.			
<u>APPLICABLE REQUIREMENTS</u>			
CSA-C22.2 No.107.1-16		- Power Conversion Equipment	
DQD 507 Rev. 2019-04-30		© 2018 CSA Group. All rights reserved.	
		Page 1	

10.20 Product Certificate of Compliance



Certificate: 80062600

Master Contract: 273488

Project: 80173205

Date Issued: 2023-09-15

- | | |
|------------------|---|
| *UL Std No. 1741 | - Inverters, Converters, Controllers and Interconnection System Equipment for Use With Distributed Energy Resources (Third Edition, Dated May 18, 2021) |
| **UL 1699B | - Photovoltaic (PV) DC Arc-Fault Circuit Protection (First Edition, Revision Dated August 22, 2021) |
| **UL1741 CRD | - Non-Isolated EPS Interactive PV Inverters Rated Less Than 30Kva (Dated April 26, 2010) |

For Transformerless Utility Interactive PV Inverter:

*Note: Conformity to UL 1741 (Third Edition, Dated September 28, 2021) includes compliance with applicable requirements of IEEE 1547-2003(R2008), IEEE 1547a-2014, IEEE 1547.1-2005(R2011), IEEE 1547.1a-2015.

For Transformerless Grid Support Utility Interactive PV Inverter:

*Note: Conformity to UL 1741(Third Edition, Dated September 28, 2021) and Grid support function is verified according to UL 1741 Supplement SA8-SA18 with the SRDs of California Electric Rule 21 and also verified according to UL 1741 Supplement SB and IEEE 1547.1-2020 with the SRDs of IEEE 1547-2018, IEEE 1547a-2020 and Hawaiian Electric Co. SRD-V2.0. While the grid support function evaluated according to IEEE 1547.1-2020, the interoperability is verified with IEEE 2030.5-2018 communication protocol.

**Note: The functional safety has been evaluated according to applicable requirement of UL 1998-Edition 3 as required by the product standard.

Notes:

Products certified under Class C531109 have been certified under CSA's ISO/IEC 17065 accreditation with the Standards Council of Canada (SCC). www.scc.ca



10.20 Product Certificate of Compliance



Supplement to Certificate of Compliance

Certificate: 80062600

Master Contract: 273488

The products listed, including the latest revision described below, are eligible to be marked in accordance with the referenced Certificate.

Product Certification History

Project	Date	Description
80173205	2023-09-15	Updated report 80062600 to add model S6-GC30K-LV-US and evaluate the Grid support function to comply with UL 1741 Supplement SA8-SA18 with the SRDs of California Electric Rule 21 and UL 1741 Supplement SB according to IEEE 1547.1-2020 with SRDS IEEE 1547-2018 and IEEE 1547a-2020.
80155184	2023-09-13	Updated report 80062600 to evaluate the Grid support function to comply with HECO SRD V2.0 requirements for Transformerless Grid Support Utility Interactive PV Inverter, firmware number is A2.
80103314	2023-08-31	Updated report 80062600 to meet requirements of UL 1699B Photovoltaic (PV) DC Arc-Fault Circuit Protection (First Edition, Revision Dated May 18, 2021) for all models.
80155183	2023-06-02	Updated report 80062600 to add Models S6-GC25K-US, S6-GC30K-US, S6-GC33K-US, S6-GC36K-US, S6-GC40K-US, S6-GC50K-US, S6-GC60K-US and evaluate the Grid support function to comply with UL 1741 Supplement SB according to IEEE 1547.1-2020 with SRDS IEEE 1547-2018 and IEEE 1547a-2020.
80062600	2022-03-26	Transformerless Utility Interactive PV Inverter, Models Solis-15K-LV-5G, Solis-20K-LV-5G, Solis-23K-LV-5G, Solis-40K-HV-5G, Solis-50K-HV-5G and S5-GC15K-LV, S5-GC20K-LV, S5-GC23K-LV, S5-GC40K-HV, S5-GC50K-HV. (C/US)

10.2.1 Mechanical Dimension Drawing

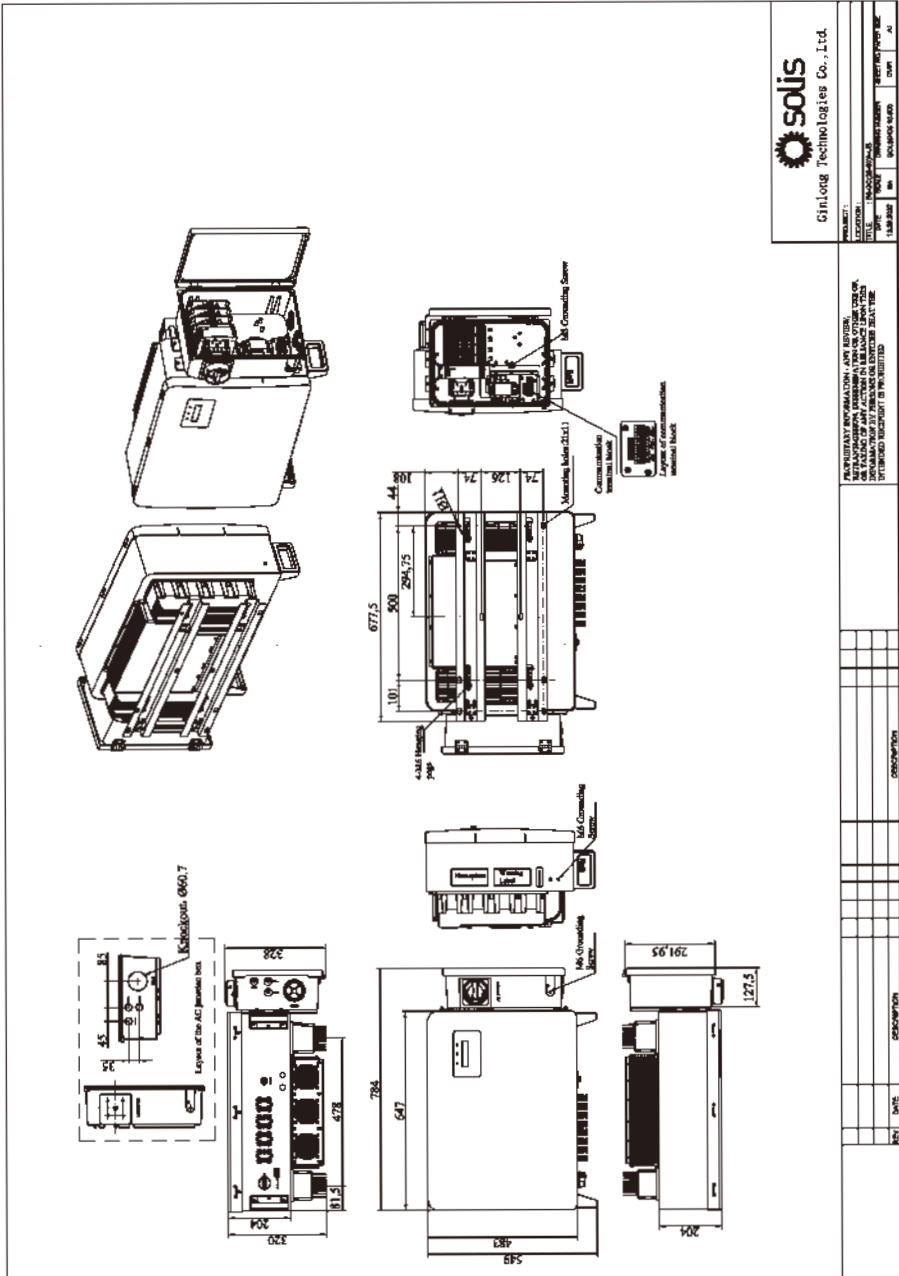

If you encounter any problems with the inverter, please take note of the inverter serial number and then contact us using the phone number or email listed above.



**SunSpec
Certified**



**Compliant with CA Rule 21 & HECO Rule 14H
Certified to UL 1741 SA and UL 1741 SB
Certified to UL Std. No. 1741-Second Edition
& CSA-C22.2 No.107.1-16**