

Portable Power Station

HPQ1000E

User manual



Thank you for purchasing and using this product:

- ★Be sure to read the user manual carefully before using the product.
- ★Be sure to keep the user's manual properly for future reference.
- ★Please fully understand the contents of the user manual to use the product properly.

Energycreative (Shenzhen) Technology Co., Ltd.

CATALOGUE

1.Disclaimer	1
2. Safety Guidelines	2
2.1 Safety notice	2
2.2 Application notice	2
2.3 Abandonment processing	3
3.Parts List	3
4.Specification Parameter	4
5.Getting Started Guide	5
5.1 Product appearance introduction	5
5.2 Screen Interface Introduction	5
5.3 User instruction	6
5.4 Function setting method	6
5.5 AC charging	7
5.6 Solar battery charging	7
5.7 On-board recharging	7
6.Maintaining	8
7.FAQ	8
8.Fault Display And Troubleshooting	9
9.After-sales Service	10

DISCLAIMER

Dear users:

Thank you very much for using our products.

Before using the product, please read the user manual carefully and ensure that you fully understand the contents of the manual and all precautions before using the product correctly. After that, please keep the user manual securely for future reference. If this product is not correctly operated, it may cause serious injury to yourself or others, damage to the product and property loss during use. Once you use this product, it is deemed that you have understood, recognized and accepted all the terms and content descriptions of this manual. Users undertake to be responsible for their own actions and all consequences arising therefrom. The Company will not be liable for all losses caused by users' failure to use the products according to the User Manual.

Subject to compliance with laws and regulations, The company has the right of final interpretation of this manual and all related documents of this product. In case of update, revision or termination, without advance notice, please visit the official website or formal sales channels to download the latest product information.

2. SAFETY GUIDELINES

2.1 Safety notice

1. Do not use or store this product near heat sources, such as fire sources or heating furnaces.
2. It is strictly prohibited to use or store this product in the environment with flammable and explosive liquid, gas or corrosive.
3. Do not use or store this product in rain or damp environment.
4. Do not use this product in the environment of strong static electricity or strong magnetic field.
5. It is forbidden to disassemble or prick the product with sharp objects in any way.
6. Do not use wires or other metal objects to cause short circuit of the product.
7. Do not squeeze or pile other heavy objects on the product, otherwise it may cause internal short circuit, burn or even explosion.
8. Please avoid collision, fall, violent vibration, if the product encountered serious external force impact, please immediately turn off the power to stop using.
9. Do not expose the product to direct sunlight for a long time. If the internal heat dissipation system is not enabled before the product is started, the battery temperature will rise sharply due to the exposure, which may cause risks.
10. If this product accidentally falls into water during use, please immediately place it in a safe and open area away from the product until it is completely dry. And the dried product shall not be used again.
11. This product has a plastic cover. In non-AC bypass mode, the AC output is not grounded. Do not use this product when the device has strict grounding requirements.
12. Please place the product carefully to prevent damage caused by dumping. If the product is dumped and seriously damaged, shut it down immediately, place the product in an open area away from combustibles and people, and scrap it in accordance with local laws and regulations.
13. This product is not a toy. Please keep this product out of reach of children and pets.
14. In case of fire, use sand, fire blanket, dry powder extinguisher, or carbon dioxide extinguisher.

2.2 Application notice

1. If you use this product for the first time, there may be insufficient power because the battery is transported with low electric energy. Please fully charge the product before using it.
2. Please use the product in a well-ventilated area and do not restrict the ventilation of the product in any way.
3. Do not use this product in flammable and explosive environments such as gasoline, gas, chemical agents and mines. Otherwise, it may cause fire or even explosion.

4. Inductive electrical appliances such as refrigerators, air conditioners, air pumps, etc. have a large starting (peak) power in use, which exceeds the rated power or peak power of the product, which will lead to the product trigger protection and shut down the output. In addition, a few devices may be mismatched with the product due to limited battery charger compatibility and cannot be used normally.
5. During the use of this product, such as earthquake, flood, typhoon, fire and other force majeure factors caused by loss, the company is not liable.
6. Do not use non-official parts or accessories, If you need to replace, please go to the official sales channel for relevant purchase information.
7. This product is not suitable for use in medical devices, aerospace and other equipment involving personal safety, and is not suitable for use in equipment requiring a highly reliable power supply. If the product is used on the above equipment, the company shall not be liable for any personal injury or accident caused by the fault of the product, or for any false alarm or misoperation caused by the related equipment.
8. Warning: Operation of this equipment in a residential environment could cause radio interference.
9. When using the product, strictly follow the ambient temperature specified in this manual. If the temperature is too high, the battery may catch fire or even explode. If the temperature is too low, it will seriously affect the performance of the product, and even can not meet the normal use requirements.
10. When using the wireless charging function of this product, no metal foreign bodies are allowed between the charging device and this product to avoid the normal use of the wireless charging function or heat during use.

2.3 Abandonment Processing

1. This product contains batteries. It is strictly prohibited to discard them in ordinary dustbins. For specific requirements, follow the local laws and regulations on battery recycling and scrapping.
2. If the product needs to be discarded, discharge the battery thoroughly if conditions permit, and then discard the product in the designated battery recycling place.
3. If the battery cannot be completely discharged due to the fault of the product itself, do not discard the battery directly at the battery recycling place. Contact a local professional battery recycling enterprise to complete the recycling and scrap of the battery under its guidance.

3. PARTS LIST



Power supply host

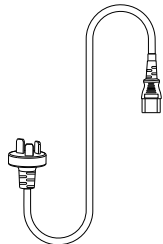

AC input wire

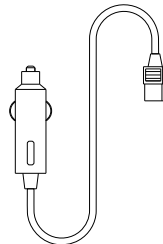

Car charger input wire

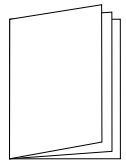

User manual

4.SPECIFICATION PARAMETER

MODEL	HPQ1000E
Basic Parameter	
Battery Capacity	768Wh
Dimensions(W*D*H)	336*218*203mm
Weight	9.7kg
Output Parameter	
AC Output (*2)	230V~4.4A,50/60Hz,Total 1000W(Peak2000W)
AC Output bypass mode(*2)	220 - 240V~,50/60Hz,9A Max
USB-A2 Output(*2)	5V==2.4A
USB-A1 Fast charge output(*1)	5/9/12V===1.5A,18W Max
TYPE-C Output(*2)	5/9/12/15V===3A;20V===5A,100W Max
DC12V(5521 Port) Output (*2)	Single 12V===3A
Car Charging Port Output (*1)	12V===10A,(And DC12V total output 120W Max)
Wireless Charging Output (*1)	5W/7.5W/10W/15W
LED Emergency Lighting (*1)	2W,Three modes of adjustment
Input Parameter	
AC Input	220 - 240V~,50/60Hz,10A Max
Solar/DC Input	11 - 50V===,15A/400W Max
Battery Parameters	
Batteries Materials	LiFePO ₄
Standard Cycle Life	3000 cycles to 80+% capacity
Safety Protection Function	Over charge and over discharge protection,Overload protection, High and low temperature protection, Short circuit protection
<p>The standard cycle life of the battery is the data measured in the laboratory at the ambient temperature of 25°C. The actual data may vary according to the user's specific usage.</p>	
Work Environment	
Charging Ambient Temperature	0 - 40°C
Discharge Ambient Temperature	-10 - 40°C
Storage Ambient Temperature	-20 - 45°C
Humidity	10% to 90% Relative humidity(Non-condensation)
Protection Degree	IP20
Whether the product can be charged and discharged normally depends on the actual temperature of the built-in battery pack.	

Specifications are subject to change without advance notice.

5. GETTING STARTED GUIDE

5.1 Product Appearance Introduction

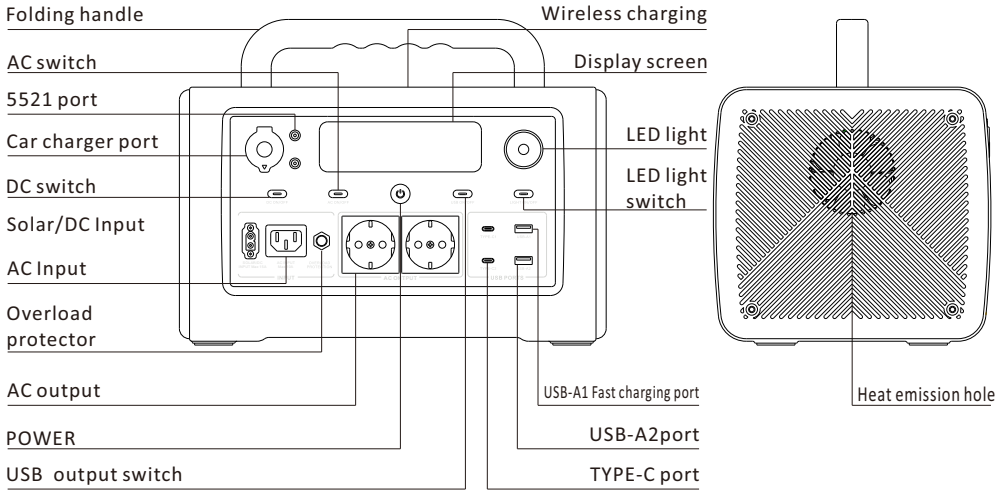

5.2 Screen Interface Introduction

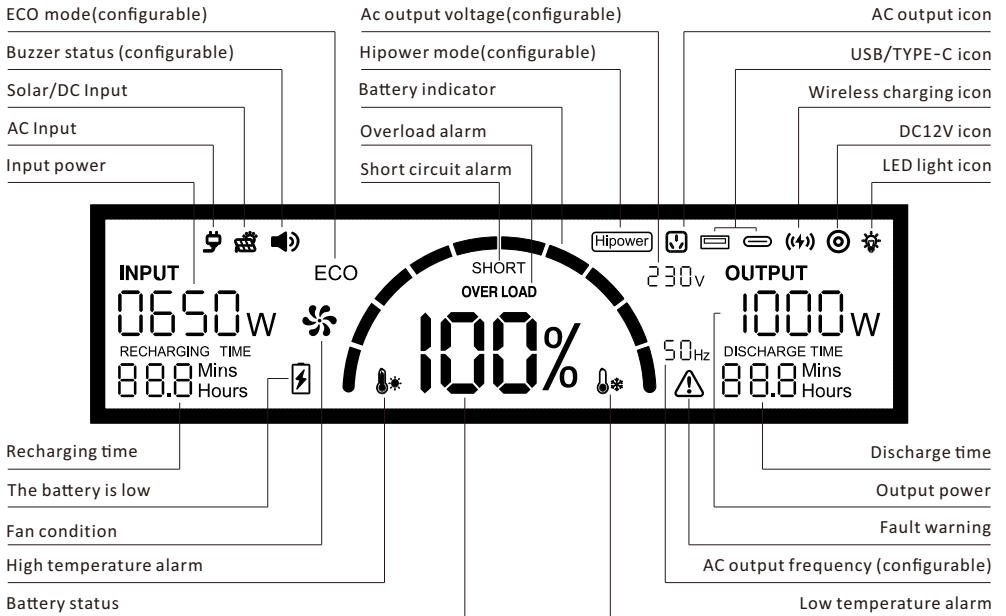

 If a fault occurs, see Section 8 for details.

5.3 User Instruction

◆ STARTING UP

When the product is off, press the main power switch to turn on the power supply. Only after the main power switch is turned on, can the function switches of other areas be operated.

Power Supply



◆ SHUTDOWN

When the product is on, long press (3S) the main power switch to turn off the power. When the product is charging, the product will not shut down to ensure that the charging continues.

◆ AC output function

After the main power switch is turned on, press the AC switch on the side to turn on the AC output function, and press the AC switch again to turn off.

◆ USB output and wireless charging output function

After the main power switch is turned on, press the USB switch to turn on the USB output function and wireless charging function, and press the USB switch again to turn off.

◆ DC12V output function (car charger port and 5521 port)

After the main power switch is turned on, press the DC switch to turn on the DC12V output function. Press the DC switch again to turn off the DC output function.

◆ LED light function

After the main power switch is turned on, press the LIGHT switch to turn on the LED LIGHT first gear, continue to press the LIGHT switch to switch to the second gear of the LED light, press the light switch again to switch to SOS mode, and so on.

5.4 Function setting method

Function Settings must be performed when the system is powered on.

All the following Settings are set in this state by default

1. Hold down the USB switch for 5S. If SET0 is displayed on the INPUT screen, the setting state is entered.
2. Short press (1S) LIGHT switch, turn the page successively, display SET0, 1, 2, 3, 4.
3. Press the DC switch (1S) to set the setting value of the corresponding item.
4. Hold down the USB switch for 5S or wait for 20S to save the Settings and exit.



show	Corresponding item	Setting instructions
SET0	Frequency setting	Set the value to 50Hz or 60Hz
SET1	Output voltage setting	It can be set to 220V, 230V, 240V
SET2	Buzzer Settings	Select ON/OFF to turn on or off
SET3	HIPOWER function Settings	Select ON/OFF to turn on or off
SET4	ECO Mode Setting	Select ON/OFF to turn on or off

The **HIPOWER** function is quick to set:

Hold down the AC switch for 5S to enable or disable the **HIPOWER** function.

ECO mode: When the ECO mode is enabled (the ECO icon on the display is on), the output power of the device is less than 5W. After four hours, the device automatically hibernates to prevent leakage.

When the ECO mode is disabled, the system does not automatically go to sleep as long as there is output power.

5.5 AC Charging

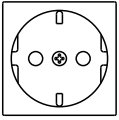

AC input wire

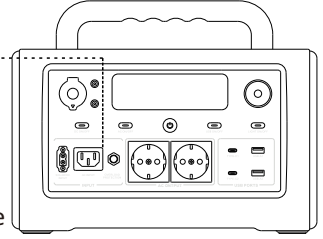

AC Charging: 220-240V~, 10A Max

It can be fully charged in about 1.3 hours on pure charge.

Bypass output can be loaded and charged at the same time, up to 9A.

⚠ Bypass mode, the AC input and AC output are directly connected, and the AC output cannot be short-circuited.

If the overload protector action is triggered during charging, remove the AC charging cable and press the overload protector button to reset.

5.6 Solar Battery Charging

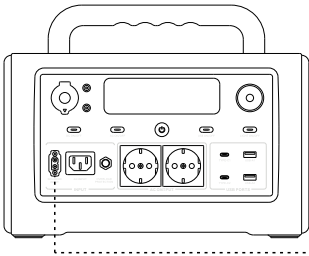

Solar charging cable connection



Solar/DC Charging: 11-50V=, 15A/400W Max

For example: 200W solar panels can be filled in about 4-7 hours.

Please ensure that the output voltage of the solar panel is below 50V, so as not to trigger the protection mechanism of the product or even cause irreversible damage to the product.



5.7 On-board Recharging

Note: Please charge the product after the car starts, so as not to cause the car to lose power and cannot start, and ensure that the car charger port and the car charger plug on the car charging line are in good contact.

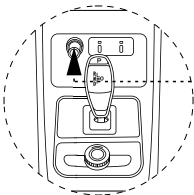

Car charger input wire

Supports 12V= car charger, 100W Max.

The car can be filled in about 9 hours after starting.

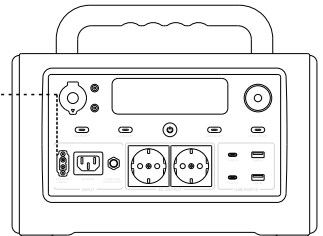

⚠ After the car is exposed to the sun, the internal temperature can reach more than 60 °C, do not use or store this product in the car, and do not allow to charge this product in a high temperature environment.

6. MAINTAINING

- 1.The best operating temperature of this product is 20°C to 30°C. It is recommended to use or store in this environment.
- 2.When the product is dirty, use a dry cloth to clean the product. do not use a wet towel to wipe the product.
- 3.If it is stored for a long time, please charge and discharge the product every 3 months (discharge to 30% and then charge to more than 60%). to extend the battery life.
- 4.If the power of this product is exhausted after use, please charge it to more than 60% before storage, avoid low power storage.
- 5.If the product is stored for a long time when the battery power is seriously insufficient, it will cause irreversible damage to the battery and shorten the subsequent service life of the product.
- 6.After a long time of idle, it is best to fully charge before use again.

7. FAQ

1. How to know the battery life when using this product?

The battery life time will be displayed on the display screen of this product, and the general power stable equipment can be referred to this time.

2. What type of battery does this product use?

The product uses lithium iron phosphate power battery, which has stronger safety and longer cycle life.

3. How to store the product reasonably when it is idle?

When storing the product, please ensure that the product is turned off, and then stored in a dry, ventilated room temperature environment, do not store the product near a water source or fire source.

4. What equipment can be used for AC output of this product?

The rated AC output power of the product is 1000W, the peak power is 2000W, and the product has Hipower function, which can supply power to some devices that do not exceed 2000W. The specific need is determined according to the type of equipment. It is recommended that you verify the power size of the equipment before use, and ensure that the sum of all load power is less than the rated power.

5. How to tell if the product is charging?

When the product is charging, the battery cell on the display screen flashes in cycles, RECHARGING TIME displays the time required for the distance to be fully charged, and INPUT displays the input power.



























6. What should I pay attention to when traveling with this product?

Avoid strong turbulence or collision during travel, so as not to squeeze the battery and cause thermal failure. Due to the built-in large capacity battery pack of this product, it is not allowed to carry this product on the plane, high-speed rail, etc.

7. Can this product be used to charge the car battery when it loses power?

This product can charge the car battery to meet the needs of emergency use, but if the car battery has other problems, it will also lead to charging failure.

8. FAULT DISPLAY AND TROUBLESHOOTING

Fault icon Display		Fault Code	Fault Type	Fault Resolution
 Flicker	SHORT Light	 Light	E17 AC output short	First disconnect the AC output device, and then restart the machine to restore the normal
 Flicker	OVERLOAD Light	 Light	E18 AC output overload	Disconnect the overload device and restore it to normal after restarting the machine. Please ensure that the product is used within the rated power
 Flicker		 Light	E16 AC input exception	Disconnect the AC input, ensure that the power grid voltage and frequency are normal, and then reconnect the power grid to check whether the fault persists
 Flicker	 Light	 Light	E22 The power module is overheated	Shut down the machine first, check whether the fan works normally, and restart the machine after the temperature drops to normal
 Flicker		 Light	E21 DC input overvoltage	First disconnect the DC input and confirm whether the DC input source voltage is within the product limit range (11-50V)
 Flicker	OVERLOAD Light	 Light	E30 DC12V output overload	After the abnormal load is removed, turn on the DC12V switch again
		 Light	E07 Communication failure	Restart the machine and check whether the fault persists
 Flicker	OVERLOAD Light	 Light	E31 USB output overload	After the abnormal load is removed, turn on the USB switch again
 Flicker		 Light	E20 Power module exception	Restart the machine and check whether the fault persists
	 Light	 Light	E03 High battery temperature	First, shut down all functions of the product, and the battery will recover automatically when the temperature drops to normal
	 Light	 Light	E04 Battery temperature is too low	First, shut down all functions of the product, and restore automatically when the battery temperature rises to normal
RECHARGING TIME Flicker	 Light	 Light	E05 High temperature of battery charge	First, shut down all functions of the product, and the battery will recover automatically when the temperature drops to normal
RECHARGING TIME Flicker	 Light	 Light	E06 Low temperature of battery charging	First, shut down all functions of the product, and restore automatically when the battery temperature rises to normal
		 Light	The battery is low	Charge

Warning: If an alarm occurs during use and the alarm persists after you remove all the load and restart the device, stop using the device immediately. Do not charge or discharge the device. If the above information does not help you solve the product problem, you can consult the dealer or contact customer service.

9. AFTER-SALES SERVICE

The warranty guide:

If the product is out of order, please follow the instructions first. If the fault still cannot be eliminated, please contact the after-sales service personnel of the company. When contacting the after-sales service personnel, please provide the following information: product model, purchase date, contact number, detailed address, and product fault overview description.

Please report the specific information to the after-sales service personnel of our company, including the on-site situation, fault performance, whether it is sporadic or frequent, whether the operation method is wrong, etc., so that the after-sales personnel of our company can find the cause, and then recover or guide the user to solve the product fault. If the fault still cannot be rectified, contact the distributor.

WARRANTY CARD			
NAME		PHONE	
CONTACT ADDRESS			
DATE OF PURCHASE		WARRANTY EFFECTIVE DATE	
PURCHASING CHANNEL		S/N	
DATE			
MAINTENANCE RECORD			

★ During the warranty period, the products in the material and process defects and non-human caused by the damage, the company will provide free repair and replacement parts, the residual parts belong to our company.

During the warranty period, if there are the following circumstances can not enjoy free maintenance services

1. Open the product without permission;
2. Damage to the surface appearance of the product is not within the scope of warranty;
3. Damage caused by the user's failure to use the product in accordance with the user manual;
4. Failure or damage caused by accident, human (operation error, collision extrusion, water and damp) and other factors;
5. Product packaging and accessories are not within the scope of warranty.

